

# Technical Manual

## WDGA absolute rotary encoders with Profinet interface

For Firmware < 1.99



**EnDra**<sup>®</sup>  
Technology

## Impressum

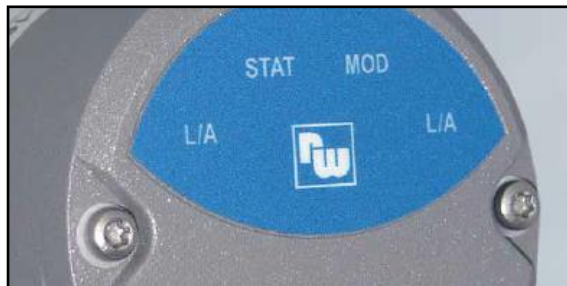

### **Wachendorff Automation GmbH & Co. KG**

Industriestrasse 7

D-65366 Geisenheim

Tel: +49 (0) 67 22 / 99 65 25

E-Mail: [support-wa@wachendorff.de](mailto:support-wa@wachendorff.de)

Homepage: [www.wachendorff-automation.de](http://www.wachendorff-automation.de)

Wiesbaden District Court HRA 8377, VAT ID: DE 814567094

Managing Director: Robert Wachendorff

### **Guarantee waiver, right of amendment, copyright protection:**

The company Wachendorff Automation assumes no liability and provides no guarantee for the correctness of this manual's contents or for any resulting direct or indirect damages. In the interests of continuous innovation and cooperation with our customers, we reserve the right to change technical data or content at any time.

The company Wachendorff Automation claims copyright protection for this manual. It may not be modified, extended, reproduced, or forwarded to third parties without our prior written consent.

Comments:

Should you have any suggested corrections, comments or requests for change, we invite you to submit them to us. Please send your comments to: [support-wa@wachendorff.de](mailto:support-wa@wachendorff.de)

<b>1</b>	<b>Introduction .....</b>	<b>1</b>
1.1	About this manual.....	1
1.1.1	Symbols .....	2
1.1.2	You will not find the following in this manual: .....	2
1.2	Product assignment.....	3
1.3	Specifications .....	4
1.4	Scope of delivery .....	4
<b>2</b>	<b>Safety information .....</b>	<b>5</b>
2.1	General safety information .....	5
2.2	Intended use.....	5
2.3	Safe working.....	6
2.4	Disposal.....	6
<b>3</b>	<b>Device description.....</b>	<b>7</b>
3.1	General information .....	7
3.2	Profinet.....	7
3.3	WDGA — basic principles .....	8
3.3.1	Singleturn — ST (QuattroMag®).....	8
3.3.2	Multiturn — MT (EnDra®) .....	9
3.3.3	Direction of rotation.....	9
3.3.4	Preset .....	9
3.3.5	Scaling .....	9
3.4	Connection assignments for Profinet encoders .....	11
3.4.1	BI2 — bus cover with 3x M12x1.....	11
3.5	LEDs and signalling.....	12
3.6	MAC address and IP address.....	13
<b>4</b>	<b>Profinet.....</b>	<b>14</b>
4.1	Overview of functions .....	14
4.2	GSDML modules .....	14
4.3	Signals.....	15
4.4	Structure of the signals.....	16
4.5	Telegrams .....	21
4.6	Parameters.....	22
4.6.1	Description of the most important parameters .....	22
4.7	Warnings and errors .....	26

4.7.1	Errors .....	26
4.7.2	Warnings.....	26
4.7.3	G1_XIST2 error codes .....	26
<b>5</b>	<b>Web server .....</b>	<b>27</b>
5.1	General information .....	27
5.2	Information .....	27
5.2.1	Overview .....	27
5.2.2	Diagnosis .....	29
5.2.3	Versions.....	30
5.3	Configuration .....	31
5.3.1	Network.....	31
5.3.2	Encoder.....	31
5.3.3	Firmware Update .....	32
5.4	Licence information .....	34
5.5	Contact.....	35
<b>6</b>	<b>Commissioning.....</b>	<b>36</b>
6.1	General information .....	36
6.2	Integration into a TIA project .....	36
6.3	Scaling function .....	44
6.3.1	Example scaling function singleturn 16-bit to 12-bit .....	44
6.3.2	Example scaling function multiturn.....	46
6.3.3	Executing a preset .....	48
6.3.4	Resetting a preset.....	50
6.4	Integration into a Step 7 project.....	51
<b>7</b>	<b>Technical data.....</b>	<b>57</b>
7.1	Properties .....	57
7.2	Dimensions.....	57
7.2.1	WDGA 58B .....	57
7.2.2	WDGA 58F.....	58
7.2.3	WDGA 58E .....	58
<b>8</b>	<b>Technical support.....</b>	<b>59</b>

## Index of figures

Figure 3.1: WDGA with PROFINET-IRT bus cover .....	7
Figure 5.1: Web server — overview .....	27
Figure 5.2: Diagnostic page .....	29
Figure 5.3: Versions .....	30
Figure 5.4: Network settings .....	31
Figure 5.5: Encoder information .....	31
Figure 5.6: Firmware update.....	32
Figure 5.7: Firmware update - choose file .....	32
Figure 5.8: Firmware update - Transferring file.....	33
Figure 5.9: Firmware update - Successful .....	33
Figure 5.10: Firmware update - Failed.....	34
Figure 5.11: Licence information .....	34
Figure 5.12: Contact information .....	35
Figure 6.1: Switching to project view .....	36
Figure 6.2: Manage device description file (GSD) .....	37
Figure 6.3: Installing GSDML.....	37
Figure 6.4: Switch to Devices & Networks.....	38
Figure 6.5: Hardware catalogue .....	38
Figure 6.6: Network view .....	38
Figure 6.7: Change device name.....	39
Figure 6.8: Select module.....	39
Figure 6.9: Select telegram.....	40
Figure 6.10: Change the I/O addresses.....	40
Figure 6.11: Download to device .....	40
Figure 6.12: Assigning device names.....	41
Figure 6.13: Name and PG interface .....	41
Figure 6.14: Accessible nodes.....	42
Figure 6.15: Online status information .....	42
Figure 6.16: PLC variables .....	43
Figure 6.17: Show all .....	43
Figure 6.18: Default tag table .....	43
Figure 6.19: Example of commissioning .....	44
Figure 6.20: Device overview - MAP .....	44
Figure 6.21: Assembly parameters.....	45
Figure 6.22: Default assembly parameters 16-Bit Singleturn.....	45
Figure 6.23: Configuration of 12-Bit Singleturn with scaling .....	46
Figure 6.24: Example of commissioning .....	46
Figure 6.25: Device overview - MAP .....	47
Figure 6.26: Assembly parameters.....	47
Figure 6.27: Configuration of 360 Steps/revolution and 10 revolutions .....	48
Figure 6.28: set STW2_ENC bit 10 to TRUE.....	49
Figure 6.29: set G1_STW bit 13 to TRUE.....	49
Figure 6.30: G1_STW Bit 11 default 0 = absolute .....	49
Figure 6.31: set and reset G1_STW Bit 12.....	50
Figure 6.32: SIMATIC Manager.....	51

Figure 6.33: Installing the GSDML file .....	51
Figure 6.34: Installing GSDML.....	52
Figure 6.35: Hardware catalogue .....	52
Figure 6.36: Hardware view .....	53
Figure 6.37: Assign a device name .....	53
Figure 6.38: Select via single mouse click.....	54
Figure 6.39: Select the properties and the telegram .....	54
Figure 6.40: Slot 1, highlighted green .....	54
Figure 6.41: Slot 1.2 with inserted telegram 81 .....	54
Figure 6.42: Change the I/O addresses.....	55
Figure 6.43: "Addresses" tab .....	55
Figure 6.44: Save and transmit — Download to module .....	55
Figure 6.45: Variable table.....	55
Figure 6.46: HEX position value .....	56
Figure 7.1: Dimensions WDGA 58B .....	57
Figure 7.2: Dimensions WDGA 58F .....	58
Figure 7.3: Dimensions WDGA 58E .....	58

## Index of tables

Table 3.1: Connection assignment — BI2 .....	11
Table 3.2: LED signal .....	12
Table 4.1: Functions .....	14
Table 4.2: GSDML modules .....	14
Table 4.3: Signals .....	15
Table 4.4: Structure of signal 6 NIST_A .....	16
Table 4.5: Structure of signal 8 NIST_B .....	16
Table 4.6: Structure of signal 9 G1_STW .....	16
Table 4.7: Structure of signal 10 G1_ZSW .....	17
Table 4.8: Structure of signal 11 G1_XIST1 .....	17
Table 4.9: Structure of signal 12 G1_XIST2 .....	18
Table 4.10: Structure of signal 39 G1_XIST3 .....	18
Table 4.11: Structure of signal 80 STW2_ENC .....	19
Table 4.12: Structure of signal 81 ZSW2_ENC .....	19
Table 4.13: Structure of signal 238(60000) G1_XIST1_PRESET_A .....	19
Table 4.14: Structure of signal 60001 DEBUG_STW .....	20
Table 4.15: Structure of signal 60002 DEBUG_ZSW .....	20
Table 4.16: Telegrams .....	21
Table 4.17: Supported parameters .....	22
Table 4.18: Velocity measuring units .....	24
Table 4.19: Hysteresis position .....	24
Table 4.20: Extrapolation position .....	24
Table 4.21: Filter max. RPM .....	24
Table 4.22: Filter position .....	25
Table 4.23: Filter speed .....	25
Table 4.24: Errors .....	26
Table 4.25: Warnings .....	26
Table 4.26: G1_XIST2 error codes .....	26
Table 6.1: Data content for Example .....	48

# 1 Introduction

## 1.1 About this manual

This technical manual describes the configuration and mounting possibilities for absolute-value encoders with a PROFINET interface produced by Wachendorff Automation. It supplements the other publicly available Wachendorff automation documents, e.g. data sheets, assembly instructions, leaflets, catalogues and flyers.

Ensure that you read the manual before commissioning — check beforehand that you have the latest version of the manual.

When reading, pay particular attention to the information, important notices and warnings that are marked with the corresponding symbols (see 1.1.1).

This manual is intended for persons with technical knowledge in the handling of sensors, PROFINET IRT interfaces and automation elements. If you do not have any experience in this field, request the assistance of experienced personnel before proceeding.



Keep the information provided with our product in a safe place so that you can refer to it at a later date as necessary.



- The contents of this manual are arranged in a practice-oriented manner.
- For optimum use of the device, all information in the following sections is important and should be read.



### 1.1.1 Symbols

	<ul style="list-style-type: none"><li>• The INFO symbol indicates a section that contains particularly important information for advanced use of the device.</li></ul>
	<ul style="list-style-type: none"><li>• The IMPORTANT symbol is shown next to a section of text that describes a method for solving a particular problem.</li></ul>
	<ul style="list-style-type: none"><li>• The WARNING symbol indicates that the adjacent instructions must be observed to ensure correct use of the device and to protect the user against hazards.</li></ul>

### 1.1.2 You will not find the following in this manual:

- Basic information about automation technology
- System planning
- Risks (availability, safety)
- Shielding concepts
- Reflections
- Repeaters
- Network configuration
- Bus cycle times
- FMA management services
- Transmission services
- Telegram types

## 1.2 Product assignment

This manual relates to the following encoder types produced by Wachendorff Automation:

### Solid shaft absolute encoders:

- WDGA 58A PROFINET-IRT (BI2) — (with bus cover)
- WDGA 58B PROFINET-IRT (BI2) — (with bus cover)
- WDGA 58D PROFINET-IRT (BI2) — (with bus cover)
- WDGA 58F PROFINET-IRT (BI2) — (with bus cover)

### Hollow shaft absolute encoders:

- WDGA 58E PROFINET-IRT (BI2) — (with bus cover)



- Wachendorff's PROFINET product range can be found on our website: [www.wachendorff-automation.com](http://www.wachendorff-automation.com)

## 1.3 Specifications

An encoder is a sensor that is designed to detect angular positions (singleturn) and revolutions (multiturn). The measured data and variables are processed by the encoder and provided as electrical output signals for the connected peripherals.

The patented technologies QuattroMag® (for singleturn) and EnDra® (for multiturn) are used in the WDGA series. As a result, the WDGA-series encoders from Wachendorff are maintenance-free and very eco-friendly.

The encoders whose article descriptions are listed in section 1.2 communicate via the PROFINET IRT interface.

## 1.4 Scope of delivery

The scope of delivery depends on the product variants and the details of your order. Before commissioning, check the contents of the delivery for completeness.

As a rule, the WDGA product range with a PROFINET IRT interface includes the following items:

- WDGA with PROFINET-IRT (with bus cover)
- Assembly instructions



- The corresponding GSDML file and data sheet can be downloaded from the internet:

[www.wachendorff-automation.com](http://www.wachendorff-automation.com)

## 2 Safety information

### 2.1 General safety information

	<ul style="list-style-type: none"><li>• When commissioning the encoder, ensure that you observe the assembly instructions, manual and data sheet.</li><li>• Failure to observe the safety instructions may lead to malfunctions, property damage and personal injury!</li><li>• Observe the operating instructions provided by the machine's manufacturer.</li></ul>
---	--

### 2.2 Intended use

Rotary encoders are components that are intended for installation in machines. Before commissioning (operation in accordance with the intended use), it must be determined that the machine as a whole corresponds to the EMC and Machine Directive.

A rotary encoder is a sensor that is designed to detect angular positions and revolutions and must only be used for this purpose! Wachendorff Automation manufactures and distributes encoders for use in non-safety-relevant industrial applications.

	<ul style="list-style-type: none"><li>• The encoder must not be operated outside the specified limit parameters (see data sheet).</li></ul>
---	---

## 2.3 Safe working

The installation and mounting of the encoder must only be carried out by a qualified electrician.

For the construction of electrical installations, all relevant national and international regulations must be strictly observed.

Failure to commission the encoder correctly may result in malfunction or failure.

	<ul style="list-style-type: none"><li>• All electrical connections must be tested before commissioning.</li><li>• Appropriate safety measures must be taken to ensure that no persons are harmed and no damage to the system or operating equipment occurs in the event of a failure or malfunction.</li></ul>
---	--

## 2.4 Disposal

Devices that are no longer needed or are defective must be disposed of by the user in proper compliance with the country-specific laws. It must be taken into consideration that this is a special waste of electronics and that disposal is not permitted via normal household waste.

There is no obligation by the manufacturer to take the device back. If you have any questions regarding proper disposal, contact a disposal specialist in your area.

## 3 Device description

### 3.1 General information

Various mechanical variants of the WDGA-series encoders with PROFINET-IRT are available. The required variant is determined by the need for a bus cover, the flange design and the shaft type (solid or hollow). The size is specified as 58 mm by the diameter at the flange. The following figure shows examples of WDGA-series encoders with PROFINET IRT.

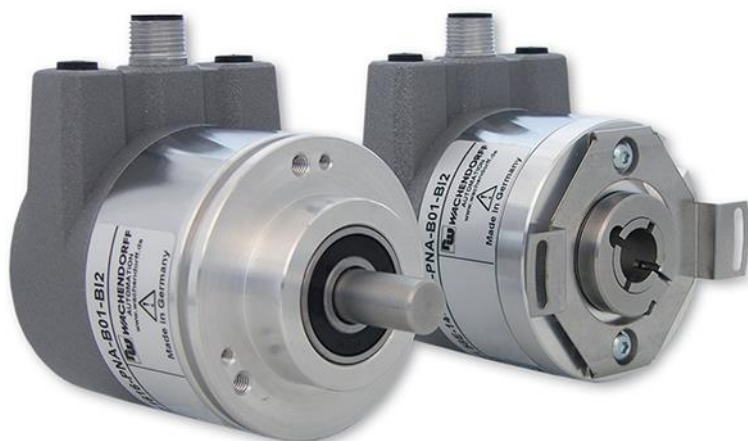

Figure 3.1: WDGA with PROFINET-IRT bus cover

The solid or hollow shaft is connected to the rotating component whose angular position or rotational speed is to be measured. Cable or plug outlets create the interface for connection to the PROFINET network. The status LEDs mounted in the cover signal the various encoder states during operation. They assist with configuration of the encoder and troubleshooting in the field. The flange holes or supplied spring sheets are used for attachment to the machine and during the respective application.

### 3.2 Profinet

Profinet is distributed by the PROFIBUS User Organization (PNO) as a successor to Profibus. Profinet is the standard interface for industrial Ethernet. Profinet provides similar functionality to Profibus, but extends these by firmware upgrades.

Established IT standards are used for the transfer of information. UDP, IP and XML form the basis for this. XML is used as a description language in the device profile (abbreviated to "GSDML file"). In order for the devices to exchange their data via IP — process data (cyclic) and parameter data (acyclic) — a unique name must be assigned to each Profinet node during configuration. The control can only assign an IP address to the node via this name.

Profinet supports the following three transmission types:

- **PROFINET NRT** (not real time), non-time-critical applications in automation, clock rates of around 100 milliseconds.
- **PROFINET RT** (real time), cyclic data traffic is used to achieve clock rates of 10 milliseconds.
- **PROFINET IRT** (isochronous real time), clock rates of 1 millisecond and jitter of less than 1 microsecond. This is suitable for use in motion-control applications (for example).

Further information about Profinet is available via the homepage of the PROFIBUS User Organization (PNO) at:

<http://www.profibus.com/technology/profinet/>

### 3.3 WDGA — basic principles

The following sections describe the basic functions of an absolute encoder.

Unlike incremental encoders, absolute-value encoders output their position value as a digital number via a fieldbus. A distinction is made here between singleturn and multiturn encoders.

In addition to simply outputting the position value, most encoders permit a certain degree of parametrization, such as selecting the positive direction of rotation, setting the position value to a reference value at a fixed physical position, and scaling the position value to an arbitrary resolution and a limited measuring range. This reduces the required complexity of the control program as well as the computational burden on the controller.

#### 3.3.1 Singleturn — ST (QuattroMag®)

Measurement of the angle from 0° to 360° by means of a shaft represents the minimum functionality of a rotary encoder. The sensor system is based on optical or magnetic sampling of a measuring graduation on the encoder shaft.

The WDGA encoders from Wachendorff feature the new QuattroMag® magnetic technology, which provides maximum precision and resolution for a singleturn encoder.

### 3.3.2 Multiturn — MT (EnDra®)

A multiturn encoder allows the number of revolutions to be recorded. This is achieved via a rotation counter. The WDGA encoders include EnDra® technology, which ensures that the corresponding information is retained, even in a voltage-free state. This means that buffer batteries and gearboxes, which require a comparatively large installation space and a correspondingly high degree of maintenance, are no longer needed.

### 3.3.3 Direction of rotation

The positive direction of rotation can be reversed by a simple two's complement of the position value (invert every bit and add "1").

### 3.3.4 Preset

The desired position value can be assigned to the encoder at a specific physical position. This must be within the measuring range so that the position value is correlated with a physical reference position. For this purpose, the difference between the current position value and the desired value is calculated. The result is stored in non-volatile memory and added to the position value as an offset.

### 3.3.5 Scaling

To ensure that the position value exactly matches the variables to be physically measured, an adjustment can be carried out via the scaling parameters. The scalable parameters are "Measuring units per revolution (MUPR)" and "Total measuring range in measuring units (TMR)".

The scaling parameter "Measuring units per revolution (MUPR)" — increments per revolution — indicates the resolution of the position value per revolution (also: ST-resolution). The value corresponds to 360°. That is, if a value of 3600 Cts is parametrized, the encoder outputs the position in 0.1° steps (see equation (2)).

$$MUPR = ST = 3600 \text{ Cts} \quad (1)$$

$$\text{Angular steps} = \frac{\text{Angle of one revolution}}{MUPR} = \frac{360^\circ}{3600 \text{ Cts}} = 0,1^\circ/\text{Cts} \quad (2)$$



The scaling parameter "Total measuring range in measuring units (TMR)" — the maximum total measuring range of the position value (singleturn and multiturn multiplied) — indicates the total resolution of the encoder. When the position value reaches TMR -1, it jumps back to 0 and vice versa.

As a rule, the selected TMR parameter should be an integer multiple of the "Measuring units per revolution (MUPR)" (see equation (4)), so that the zero point is always at the same position of the encoder shaft.

$$TMR = 36000 \text{ Cts} \quad (3)$$

$$MT = \frac{TMR}{MUPR} = \frac{36000 \text{ Cts}}{3600 \text{ Cts}} = 10 \quad (4)$$

In exceptional cases, it is suitable that TMR is not an integer multiple of MUPR — for example, in a system in which a gear ratio ensures that the desired measured variable is moving 10% faster relative to the encoder shaft.

In this case, a setting of MUPR = 3960 Cts and TMR = 36000 Cts would ensure that the faster (but not directly measurable) shaft can be measured with a resolution of 0.1° and over a range of 10 revolutions. Normally, the number of revolutions would be calculated by dividing the position value by MUPR. In this case, however, it must be divided by 3600 Cts, since the result would otherwise be the number of revolutions of the encoder shaft and not the faster shaft of the system.



- It should be noted that measurement errors will occur if the result of this formula is a decimal.

### 3.4 Connection assignments for Profinet encoders

#### 3.4.1 BI2 — bus cover with 3x M12x1

The string "BI2" in the order code identifies an encoder with a bus cover. The electrical connection is made on the bus cover via 2x M12 connectors and 1x M12 port. The connection assignments for the plugs and sockets are listed in **Fehler! Verweisquelle konnte nicht gefunden werden..**



Anschlussbelegung		Anschlussbelegung		Anschlussbelegung	
BI2		BI2.		BI2.	
					
Port (Port1)	M12x1, 4-pole, D-coded	Connector (Power)	M12x1, 4-pole, A-coded	Port (Port2)	M12x1, 4-pole, D-coded
Tx+	1	UB+	1	Tx+	1
Rx+	2	n. c.	2	Rx+	2
Tx-	3	UB-	3	Tx-	3
Rx-	4	n. c.	4	Rx-	4

Table 3.1: Connection assignment — BI2

### 3.5 LEDs and signalling

Four status LEDs on the bus cover signal the various encoder states and thus support error diagnosis and troubleshooting in the field (see Table 3.2). The two Link Activity LEDs (L/A) light up or flash green when the encoder is connected to another Profinet node (PLC, switch, additional field device...) and data is being exchanged. The STAT LED indicates the status of the fieldbus, the MOD LED the status of the encoder.

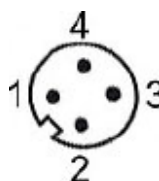
STAT LED bicolour	MOD LED bicolour	Meaning	Cause
○	○	No voltage	
●	●	No connection; no data exchange	Bus disconnection or master not accessible or switched off
✱	●	Parametrization error, no data exchange  Criterion: Data exchange correct. However, the slave does not switch to the data- exchange mode	Slave is not configured yet. Incorrect station address, but not out of range. The actual configuration of the slave differs from the nominal configuration.
●	●	System error	Diagnosis exists, slave is in data-exchange mode
●	●	Data exchange, slave and operation OK	

Table 3.2: LED signal

Explanation of symbols and asterisks:

○ LED off    ●/● LED on    ✱/✱ LED flashing

### **3.6 MAC address and IP address**

Wachendorff Profinet encoders have three MAC addresses. These always start with D4-90-E0-xx-xx-xx. The number depends on the number of ports on the integrated three-port switch. There is one MAC address each for Port1 and Port2, as well as one MAC address for the "internal port" to which the encoder itself is connected.

In the delivered state, the Profinet encoder has no IP address and no name. These are defined during configuration (e.g. TIA Portal).

## 4 Profinet

### 4.1 Overview of functions

Our Profinet encoders support the functions shown in **Fehler! Verweisquelle konnte nicht gefunden werden.:**

Functions	Meaning
Conformance class	CC-C
Profile	Encoder Profile V4.1
Profile class	Encoder Profile Class 4, as well as compatibility with Class 3
Performance	Cycle time 250 $\mu$ s (with clock synchronisation) and fast start-up of 1 s
Redundancy	MPR and MRPD
Web server	Display and configuration of parameters, firmware updates
Clock synchronisation	RT, IRT and IRT isochronous

Table 4.1: Functions

### 4.2 GSDML modules

The modules from the current GSDML file are listed in **Fehler! Verweisquelle konnte nicht gefunden werden.:**

Designation	Meaning
ST0013	No multiturn, singleturn 13 bit
ST0016	No multiturn, singleturn 16 bit
MT1413	Multiturn 14 bit + singleturn 13 bit = 27 bits in total
MT1416	Multiturn 14 bit + singleturn 16 bit = 30 bits in total
MT1616	Multiturn 16 bit + singleturn 16 bit = 32 bits in total
MT3916	Multiturn 39 bit + singleturn 16 bit = 55 bits in total

Table 4.2: GSDML modules

### 4.3 Signals

**Fehler! Verweisquelle konnte nicht gefunden werden.** shows the signals that are supported by Wachendorff Profinet encoders.

Signal	Description	Name	Length (bits)	Signed
6	Velocity A	NIST_A	16	Y
8	Velocity B	NIST_B	32	Y
9	Sensor 1 control word	G1_STW	16	-
10	Sensor 1 status word	G1_ZSW	16	-
11	Sensor 1 position 1	G1_XIST1	32	N
12	Sensor 1 position 2	G1_XIST2	32	N
39	Sensor 1 position 3	G1_XIST3	64	N
80	Encoder control word 2	STW2_ENC	16	-
81	Encoder status word 2	ZSW2_ENC	16	-
238 (60000)	Sensor position preset control word	G1_XIST_PRESET_A	32	N
60001	Debug control word	DEBUG_STW	16	N
60002	Debug status word	DEBUG_ZSW	16	N

Table 4.3: Signals

## 4.4 Structure of the signals

### NIST\_A: Velocity value A

This value includes the velocity, has a width of 16 bits and is signed.

<b>Signal</b>	NIST_A		
<b>Bits</b>	15 ... 0		
<b>Contents</b>			
<b>15 ... 0</b>	Velocity value A	Right-aligned, (see Fehler!	output in set unit Verweisquelle konnte nicht

Table 4.4: Structure of signal 6 NIST\_A

### NIST\_B: Velocity value B

This value includes the velocity, has a width of 32 bits and is signed.

<b>Signal</b>	NIST_B		
<b>Bits</b>	31 ... 0		
<b>Contents</b>			
<b>31 ... 0</b>	Velocity value B	Right-aligned, (see Fehler!	output in set unit Verweisquelle konnte nicht

Table 4.5: Structure of signal 8 NIST\_B

### G1\_STW: Sensor 1 control word

<b>Signal</b>	G1_STW					
<b>Bits</b>	15	14	13	12	11	10 ... 0
<b>Contents</b>						
<b>15</b>	Confirm sensor error	0 = Sensor error not confirmed by controller 1 = Sensor error confirmed by controller				
<b>14</b>	Park mode	0 = Normal operation 1 = Activate park mode				
<b>13</b>	Cyclically query absolute position value	0 = Do not interrogate 1 = Master performs query (cyclic output of				
<b>12</b>	Activate preset	0 = Preset not active 1 = Preset active				
<b>11</b>	Preset mode	0 = Set preset to absolute value 1 = Move preset by value (offset)				
<b>10 ... 0</b>	Reserved, currently not used					

Table 4.6: Structure of signal 9 G1\_STW



- To enable the encoder to respond to the requirements in G1\_STW, the controller must set bit 10 to 1 in STW2\_ENC.

## G1\_ZSW: Sensor 1 status word

Signal	G1_ZSW					
Bits	15	14	13	12	11	10 ... 0
<b>Contents</b>						
<b>15</b>	Sensor error		Signals a sensor error and outputs a device-specific error code in G1_XIST2			
<b>14</b>	Park mode active		Confirms "Park mode". No error messages are transmitted			
<b>13</b>	Cyclically query absolute position value		Confirms "cyclically query absolute position value"			
<b>12</b>	Preset activated		Confirms "activate preset"			
<b>11</b>	Sensor error acknowledgement active		Signals processing of the requested sensor error acknowledgement			
<b>10 ... 0</b>			Reserved, currently not used			

Table 4.7: Structure of signal 10 G1\_ZSW

## G1\_XIST1: Sensor 1 position 1

Signal	G1_XIST1	
Bits	31 ... 0	
<b>Contents</b>		
<b>31 ... 0</b>	Absolute position value 1	Right-aligned

Table 4.8: Structure of signal 11 G1\_XIST1

Structure of G1\_XIST1 using the example of a 16-bit multiturn and a 16-bit singleturn encoder:

31	30	29	28	27	26	25	24	23	22	21	20	19	18	17	16
M	M	M	M	M	M	M	M	M	M	M	M	M	M	M	M
15	14	13	12	11	10	9	8	7	6	5	4	3	2	1	0
S	S	S	S	S	S	S	S	S	S	S	S	S	S	S	S

M = multiturn / S = singleturn

This value includes the position, has a width of 32 bits and is unsigned. The encoder parameter settings influence this position value if "Class 4 functionality" is activated. The influence of the preset functionality can be controlled with "G1\_XIST1 Preset Control".



## G1\_XIST2: Sensor 1 position 2

<b>Signal</b>	G1_XIST2	
<b>Bits</b>	31 ... 0	
<b>Contents</b>		
<b>31 ... 0</b>	Absolute position value 2	Right-aligned

Table 4.9: Structure of signal 12 G1\_XIST2

This value includes the position, has a width of 32 bits and is unsigned. The encoder parameter settings influence this position value if "Class 4 functionality" is activated. When activated, the preset functionality always has an influence on G1\_XIST2.

	<ul style="list-style-type: none"> <li>• If an error occurs, G1_XIST2 contains the error register instead of the position value.</li> </ul>
---	---

## G1\_XIST3: Sensor 1 position 3

<b>Signal</b>	G1_XIST3	
<b>Bits</b>	63 ... 0	
<b>Contents</b>		
<b>63 ... 0</b>	Absolute position value 3	Right-aligned

Table 4.10: Structure of signal 39 G1\_XIST3

This value includes the position, has a width of 64 bits and is unsigned. It can be used if the measuring range of the encoder is larger than 32 bits. The encoder parameter settings influence this position value if "Class 4 functionality" is activated.

## STW2\_ENC: Encoder control word 2

Signal	STW2_ENC			
Bits	15 ... 12	11	10	9 .. 0
Contents				
15 ... 12	Sign-of-life from the PLC	Receives a count value from 1 to 15 when isochronous transmission is activated		
11				Reserved, currently not used
10	Control by PLC	0 = No control by PLC 1 = Control by PLC		
9 ... 0				Reserved, currently not used

Table 4.11: Structure of signal 80 STW2\_ENC

## ZSW2\_ENC: Encoder status word 2

Signal	ZSW2_ENC			
Bits	15 ... 12	11	10	9 .. 0
Contents				
15 ... 12	Sign-of-life from the encoder	Sends a count value of 1 to 15 when the isochronous transmission is activated and a sign-of-life has been received from the PLC		
11 ... 10				Reserved, currently not used
9	PLC requests control	0 = No control by PLC 1 = Control by PLC		
8 ... 0				Reserved, currently not used

Table 4.12: Structure of signal 81 ZSW2\_ENC

## G1\_XIST1\_PRESET\_A: Sensor position preset control word

Signal	G1_XIST1_PRESET_A	
Bits	31	30 ... 0
Contents		
31	Trigger bit	Controls the transmission of the preset value 1 = Run preset
30 ... 0	Preset value without sign	Includes the 31-bit-wide preset value

Table 4.13: Structure of signal 238(60000) G1\_XIST1\_PRESET\_A

	<ul style="list-style-type: none"> <li>This signal is intended to ensure compatibility with Siemens products. As an alternative to 238, this signal can be assigned the number 60000.</li> </ul>
---	--

## DEBUG\_STW: Debug control word

Signal	DEBUG_STW	
Bits	15 ... 1	0
Contents		
15 ... 1	0	Not used
0	Set test error	Triggers the test error when set to "0"

Table 4.14: Structure of signal 60001 DEBUG\_STW

## DEBUG\_ZSW: Debug status word

Signal	DEBUG_ZSW	
Bits	15 ... 1	0
Contents		
15 ... 1	0	Not used
0	Test error active	Indicates that the test error is set

Table 4.15: Structure of signal 60002 DEBUG\_ZSW

## 4.5 Telegrams

The supported standard telegrams and manufacturer-specific telegrams are described in **Fehler! Verweisquelle konnte nicht gefunden werden.**

	<ul style="list-style-type: none"> <li>For telegram 860, the manufacturer signal 238 (alternatively 60000) is used.</li> <li>For telegram 59000, the manufacturer signals 60001 and 60002 are used.</li> </ul>
---	--

Nr.	Dir.	Data word									
		1	2	3	4	5	6	7	8	9	10
81	SPS -> ENC	STW2_ ENC	G1_ STW								
	ENC -> SPS	ZSW2_ ENC	G1_ ZSW	G1_XIST1		G1_XIST2					
82	SPS -> ENC	STW2_ ENC	G1_ STW								
	ENC -> SPS	ZSW2_ ENC	G1_ ZSW	G1_XIST1		G1_XIST2	NIST_A				
83	SPS -> ENC	STW2_ ENC	G1_ STW								
	ENC -> SPS	ZSW2_ ENC	G1_ ZSW	G1_XIST1		G1_XIST2	NIST_B				
84	SPS -> ENC	STW2_ ENC	G1_ STW								
	ENC -> SPS	ZSW2_ ENC	G1_ ZSW	G1_XIST3			G1_XIST2	NIST_B			
860	SPS -> ENC	G1_XIST_ PRESET_A									
	ENC -> SPS	G1_XIST1		NIST_B							
59000	SPS -> ENC	STW2_ ENC	G1_ STW	DEBUG_ STW							
	ENC -> SPS	ZSW2_ ENC	G1_ ZSW	G1_XIST1		G1_XIST2	DEBUG_ ZSW				

Table 4.16: Telegrams

## 4.6 Parameters

	PNU	Sub-index	Bits	Function
Encoder profile	65000			Preset value
	65001	1	0	Code sequence
			1	Class 4 functionality
			2	G1_XIST1 preset control
			3	Scaling function control
			4	Alarm channel control
			5	Compatibility mode
		2	Faults	
		3	Supported faults	
		4	Warnings	
		5	Supported warnings	
		6	Encoder profile version	
	8	Offset value		
	9	Measuring units per revolution		
	10	Total measuring range in measuring units		
	11	Velocity measuring unit		
65002			Preset value 64 bit	
65003	1		Offset value 64 bit	
		2	Measuring units per revolution 64 bit	
		3	Total measuring range in measuring units 64 bit	
PROFI drive	922			Telegram selection
	925			Number of controller sign-of-life failures which may be tolerated
	964			Device identification
	965			Encoder profile number
	970			Load parameter set
	971			Transfer to non-volatile memory
	972			Encoder reset
	974			Base mode parameter access service identification
	975			Encoder object identification
	976			Load device parameter set
	977			Transfer in non-volatile memory (global)
	978			List of all DO-IDs
	979			Sensor format
	980...989			Number list of defined parameter
Device-specific	2000			Hysteresis position
	2002			Extrapolation position
	2003			Filter max. RPM
	2004			Filter position
	2005			Filter speed

Table 4.17: Supported parameters

### 4.6.1 Description of the most important parameters

#### 4.6.1.1 Code sequence

Defines the counting direction of the position value in relation to the encoder shaft. "0" means a positive counting direction of the position value with clockwise rotation of the shaft; "1" means a positive counting direction with counter-clockwise rotation.

#### 4.6.1.2 Class 4 functionality

Switches the scaling, preset and code sequence functionality on and off. When switched on, the position values G1\_XIST1, G1\_XIST2 and G1\_XIST3 are influenced by the scaling and the code sequence, and G1\_XIST2 and G1\_XIST3 by the preset. In addition, if "G1\_XIST1 Preset control" is also activated, G1\_XIST1 is also affected by the preset, otherwise it is not.

#### 4.6.1.3 G1\_XIST1 preset control

Controls whether a preset command affects G1\_XIST1 and is switched on with "0" and off with "1". Has no function unless "Class 4 Functionality" is activated. Only affects G1\_XIST1, i.e. if the preset function is activated and the "G1\_XIST2 Preset control" is switched off, G1\_XIST2 is nevertheless affected by the preset.

#### 4.6.1.4 Scaling function control

This parameter turns the scaling functions on and off. If it is not activated, the position values G1\_XIST1, G1\_XIST2 and G1\_XIST3 are not affected. The scaling of the velocity value is PROFIdrive-specific and is not influenced by the position scale. The current setting can be read by object P65001, sub-index 1, bit 3. To use the scaling functions, "Class 4 functionality" must be activated.

#### 4.6.1.5 Preset value

The preset value is governed by the scaling and can be reset repeatedly and stored in non-volatile memory via P971. By default has the preset value has the value 0.

Setting a preset value has no effect on the position value for the time being. The preset function is only executed by setting bit 12 in G1\_STW.

#### 4.6.1.6 Measuring units per revolution

For encoders, this parameter defines the number of increments required to resolve one 360° rotation of the encoder shaft. This parameter must be set during parametrization (octets 5...8). The current setting can be read by object P65001, sub-index 9.

#### 4.6.1.7 Total measuring range in measuring units

Defines the entire measuring range of the encoder, i.e. after how many increments the position value resets to 0. For example, if "Measuring units per revolution" is 100 and "Total measuring range" is 250, the position value will return to 0 after 2.5 revolutions of the encoder shaft.

#### 4.6.1.8 Velocity measuring units

This parameter defines the unit of the velocity values NIST\_A and NIST\_B. The following units are possible:

Unit	Parameter value
Increments / s	0
Increments / 100 ms	1
Increments / 10 ms	2
Rotations / min	3

Table 4.18: Velocity measuring units

#### 4.6.1.9 Offset value

The offset value is calculated during execution of the preset and is then added to the position value. It is stored in non-volatile memory and can be read by the encoder at any time. The offset value can assume values within the scaled measurement range.

#### 4.6.1.10 Hysteresis position

<b>Parameters</b>	<b>2000</b>
<b>Meaning</b>	Hysteresis position
<b>Data type</b>	Unsigned 8
<b>Access</b>	RW
<b>Values</b>	0 ... 255
<b>Default</b>	10
<b>Explanation</b>	Size of the hysteresis for the position value

Table 4.19: Hysteresis position

#### 4.6.1.11 Extrapolation position

<b>Parameters</b>	<b>2002</b>
<b>Meaning</b>	Extrapolation position
<b>Data type</b>	Unsigned 16
<b>Access</b>	RW
<b>Values</b>	0 ... 65535
<b>Default</b>	100
<b>Explanation</b>	Time to be compensated for in $\mu$ s "Where will the position value be in X $\mu$ s?"

Table 4.20: Extrapolation position

#### 4.6.1.12 Filter max. RPM

<b>Parameters</b>	<b>2003</b>
<b>Meaning</b>	Filter max. RPM
<b>Data type</b>	Unsigned 16
<b>Access</b>	RW
<b>Values</b>	0 ... 65535
<b>Default</b>	0
<b>Explanation</b>	0: Number of average values is constant > 0: Number of average values decreases linearly until the speed indicated here is reached

Table 4.21: Filter max. RPM

#### 4.6.1.13 Filter position

Parameters	2004
Meaning	Filter position
Data type	Unsigned 8
Access	RW
Values	0 ... 255
Default	5
Explanation	Number of average values for the position value

Table 4.22: Filter position

#### 4.6.1.14 Filter speed

Parameters	2005
Meaning	Filter speed
Data type	Unsigned 8
Access	RW
Values	0 ... 255
Default	5
Explanation	Number of average values for the velocity value

Table 4.23: Filter speed



## 4.7 Warnings and errors

### 4.7.1 Errors

Bits	Meaning	Sensor system error code
0	Position error	All have invalid position values
5	Memory error	11

Table 4.24: Errors

### 4.7.2 Warnings

Bits	Meaning	Sensor system error code
0	Frequency exceeded	-

Table 4.25: Warnings

### 4.7.3 G1\_XIST2 error codes

G1_XIST2	Meaning	Sensor system error code
0x0001	Sensor group error	All have invalid position values
0x0F01	Command not supported	-
0x0F02	PLC sign-of-life error	-
0X0F04	Synchronisation error	13

Table 4.26: G1\_XIST2 error codes

## 5 Web server

### 5.1 General information

Profinet encoders have a web server that lets you view specific information and configure certain settings. To access the web server, enter its IP address into a browser of your choice (Internet Explorer, Firefox, etc.). To do so, connect the encoder to your computer using an Ethernet cable (M12 connector on the encoder and RJ45 connector on the PC). Ensure that your PC is in the same IP address range as the encoder.

	<ul style="list-style-type: none"> <li>Example configuration:                     <table style="margin-left: 20px;"> <tr> <td>IP address of the encoder:</td> <td>192.168.0.1</td> </tr> <tr> <td>IP address of the PC:</td> <td>192.168.0.100</td> </tr> <tr> <td>Subnet address of the PC:</td> <td>255.255.255.0</td> </tr> </table> </li> </ul>	IP address of the encoder:	192.168.0.1	IP address of the PC:	192.168.0.100	Subnet address of the PC:	255.255.255.0
IP address of the encoder:	192.168.0.1						
IP address of the PC:	192.168.0.100						
Subnet address of the PC:	255.255.255.0						



Once this has been done, the encoder's homepage opens (information overview).

The following sub-sections cover the various views within the web server and the available functions.

### 5.2 Information

#### 5.2.1 Overview



Language:  

Information
Configuration
Licence
Contact

#### Overview

Device type:	Wachendorff Encoder
Serial number:	172200107
Operating time in hours:	00:05
Protocol:	PROFINET IO
Status device:	Running
Status stack:	Online
Device name:	
MAC Device:	D4:90:E0:00:00:01
MAC Port 1:	D4:90:E0:00:00:02
MAC Port 2:	D4:90:E0:00:00:03
IP address:	192.168.0.1
Netmask:	255.255.255.0
Gateway:	0.0.0.0

Refresh (10s)

Figure 5.1: Web server — overview

The overview displays the following information:

- Device type: name of the encoder
- Serial number: device number of the encoder
- Operating time in hours: number of operating hours
- Protocol: Profinet IO
- Device status: on or off state
- Status stack: Online or offline
- MAC devices: MAC address of the encoder
- MAC Port 1: MAC address of Ethernet port 1
- MAC Port 2: MAC address of Ethernet port 2
- IP address: IP address of your Profinet encoder
- Network mask: the subnet mask of your Profinet encoder
- Gateway: the gateway of your Profinet encoder

The update rate of the web page is fixed at 10 seconds and cannot be changed. The message "Updating Data" in the upper-right corner of the field in which the update time is displayed indicates that the data is being updated.

You can change the language of the web server after accessing it. After switching inside a sub-screen, the web server restarts from the start screen.

## 5.2.2 Diagnosis

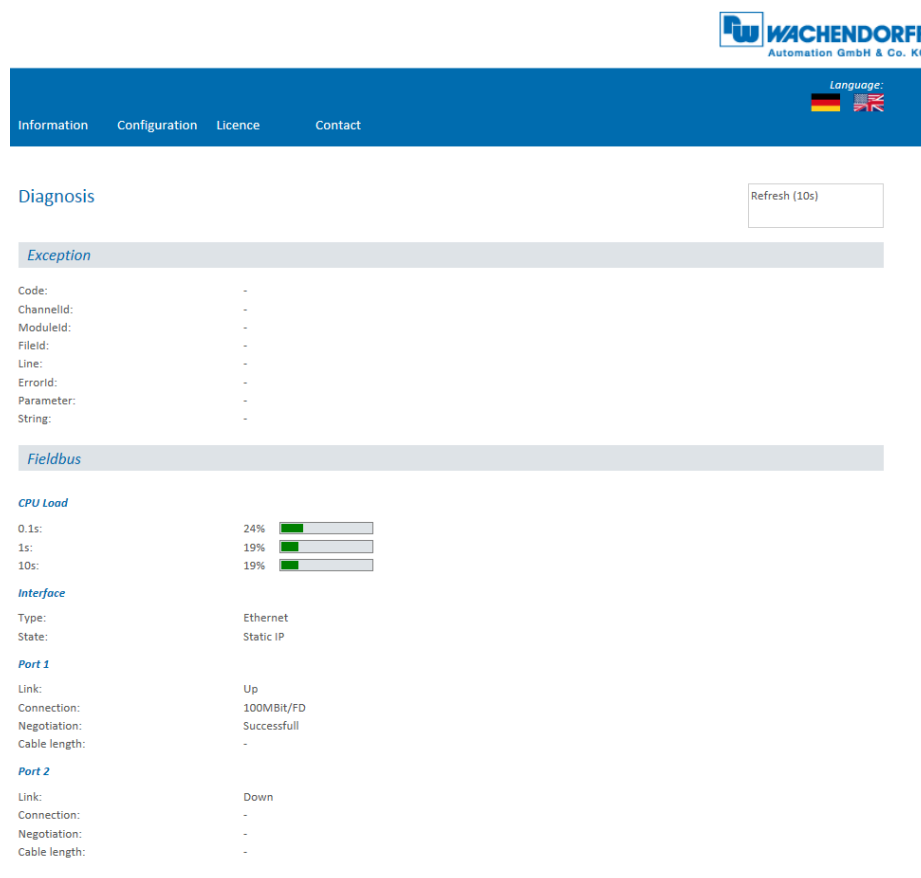

Figure 5.2: Diagnostic page

### Exception

Possible causes of errors are displayed here. If you see an error here, please either contact us or refer to the manual for possible causes.

### Fieldbus

- CPU Load: this shows the CPU utilisation of the encoder during operation.
- Interface:
  - Type: the protocol is displayed here; Ethernet
  - State: the mode is specified here. Only static IP is specified. DHCP mode is not possible.
- Port 1 and Port 2
  - Link: indicates whether the port is active. Link=> up or down
  - Connection: max. speed 100Mbit/FD
  - Negotiation: allows two interconnected Ethernet ports to negotiate independently and configure the maximum possible speed.
  - Cable length: when using IRT mode, the cable length specified in the TIA Portal is displayed.

### 5.2.3 Versions

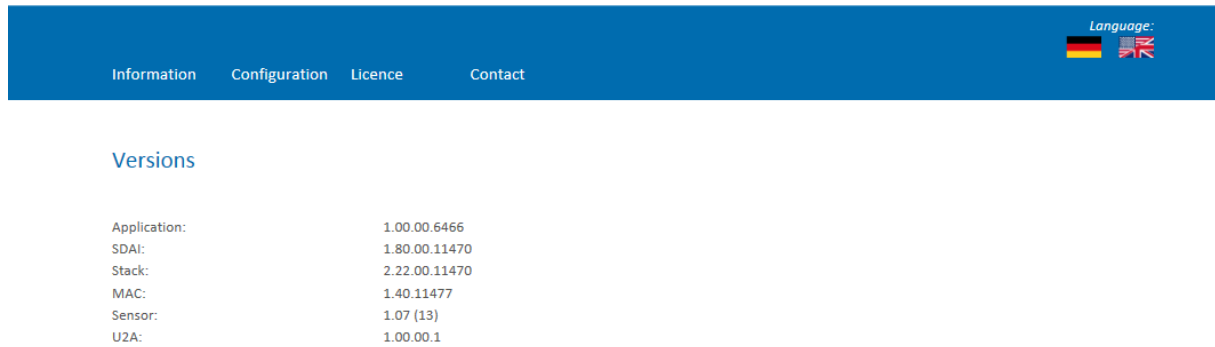

Figure 5.3: Versions

Here you can find information about the individual versions:



- Application
- SDAI
- Stack
- MAC
- Sensor
- U2A

## 5.3 Configuration

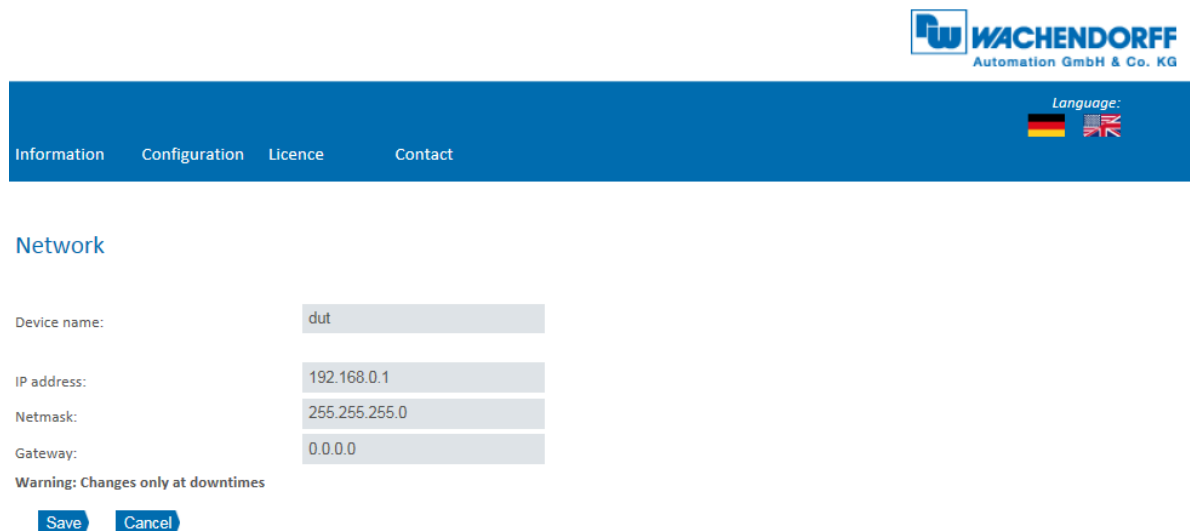
### 5.3.1 Network



Information Configuration Licence Contact

Language:  

Network

Device name: dut

IP address: 192.168.0.1

Netmask: 255.255.255.0

Gateway: 0.0.0.0

Warning: Changes only at downtimes

Save Cancel

Figure 5.4: Network settings



You can change the device name, IP address, network mask and gateway here.

	<ul style="list-style-type: none"><li>• Please note that this data should only be modified when the system is not in operation.</li></ul>
---	---

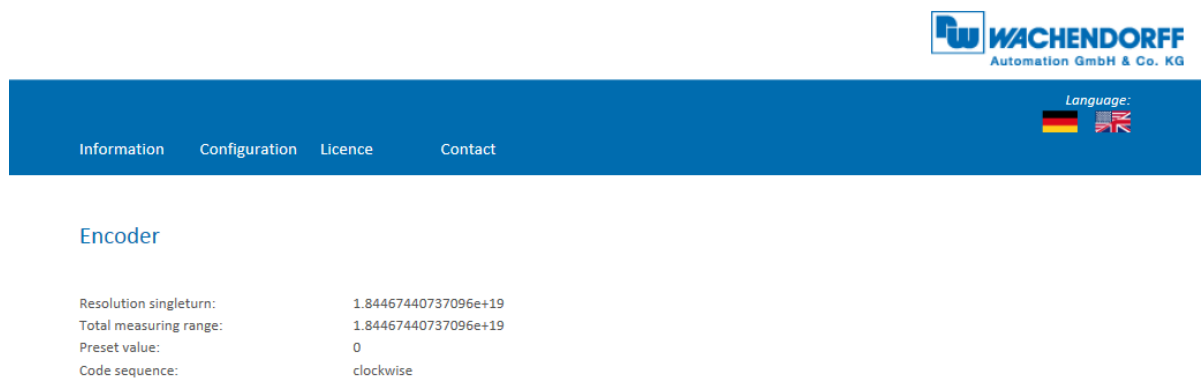
### 5.3.2 Encoder



Information Configuration Licence Contact

Language:  

Encoder

Resolution singleturn: 1.84467440737096e+19

Total measuring range: 1.84467440737096e+19

Preset value: 0

Code sequence: clockwise

Figure 5.5: Encoder information

You can check the following parametrized values for the encoder here:

- Resolution singleturn
- Total measuring range
- Preset value
- Code sequence

### 5.3.3 Firmware Update

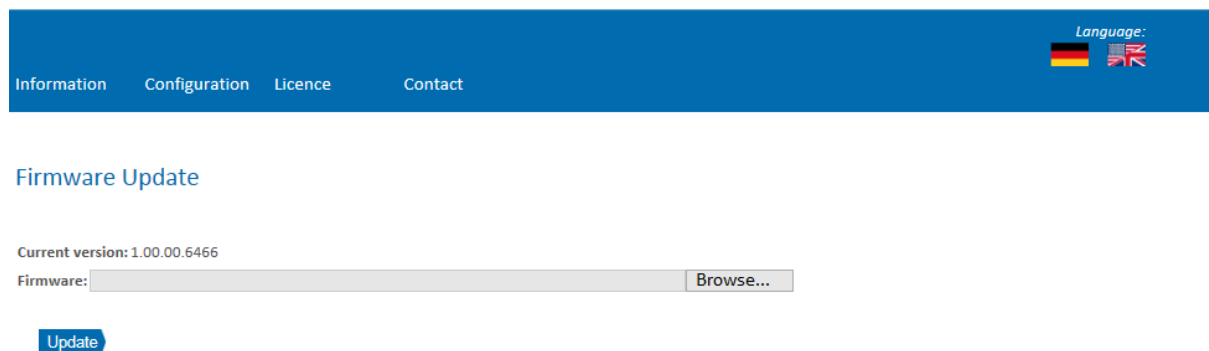

Figure 5.6: Firmware update

The current firmware version of the encoder is displayed. If a new firmware version is available, you can update the encoder's firmware here.

	<ul style="list-style-type: none"><li>• Please note that the firmware must only be updated when the system is not in operation.</li><li>• Do not cut off the power supply or disconnect the network cable while performing a firmware update.</li></ul>
--	---

To update the firmware of the encoder, choose the correct .bin file by clicking the “Browse...”-Button (see Figure 5.7: Firmware update - choose file).

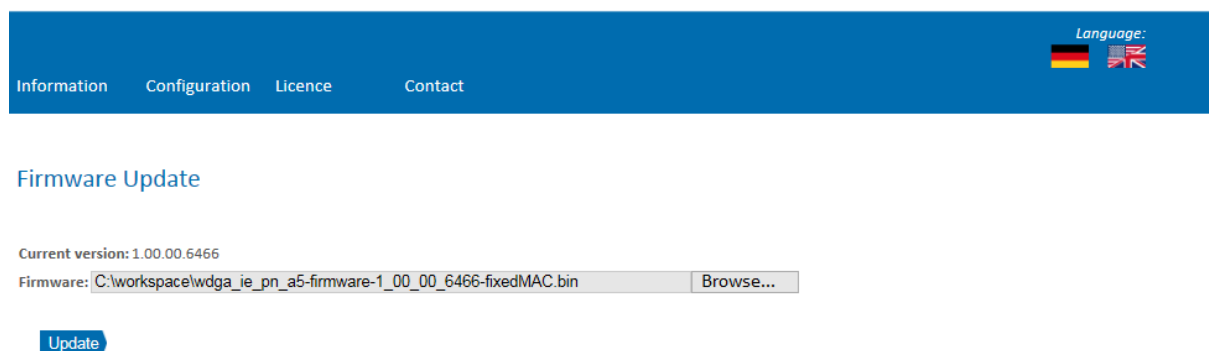

Figure 5.7: Firmware update - choose file

After you have chosen the correct file, click the “Update”- Button to start the firmware update. An animated icon will appear with the additional text: “Transferring file” (see Figure 5.8).

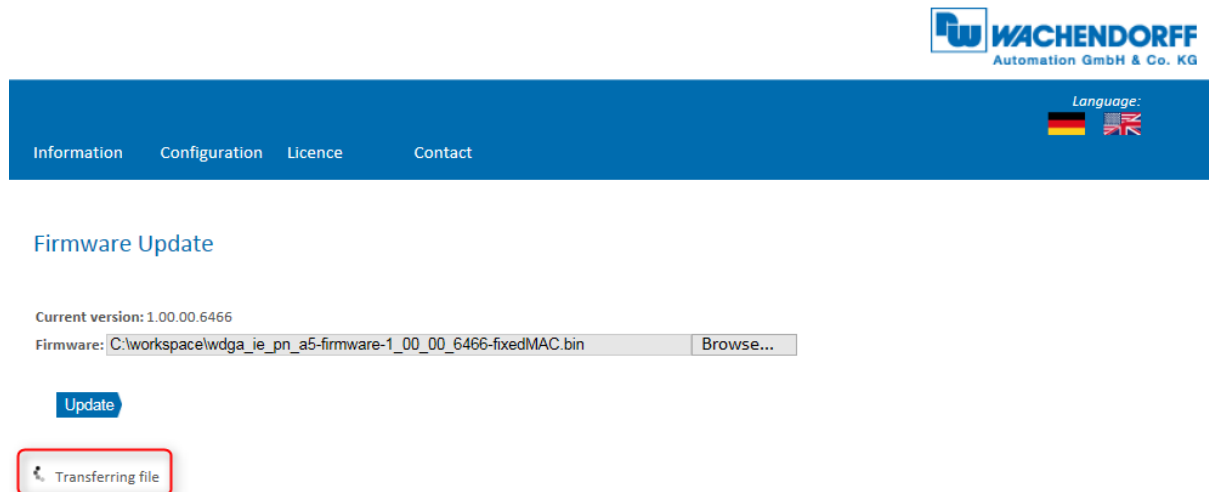

Figure 5.8: Firmware update - Transferring file

After the firmware update is successfully finished, you will see it on the website like in Figure 5.9. Perform now a power reset and check under “Information -> Versions”, if the new firmware version is shown.

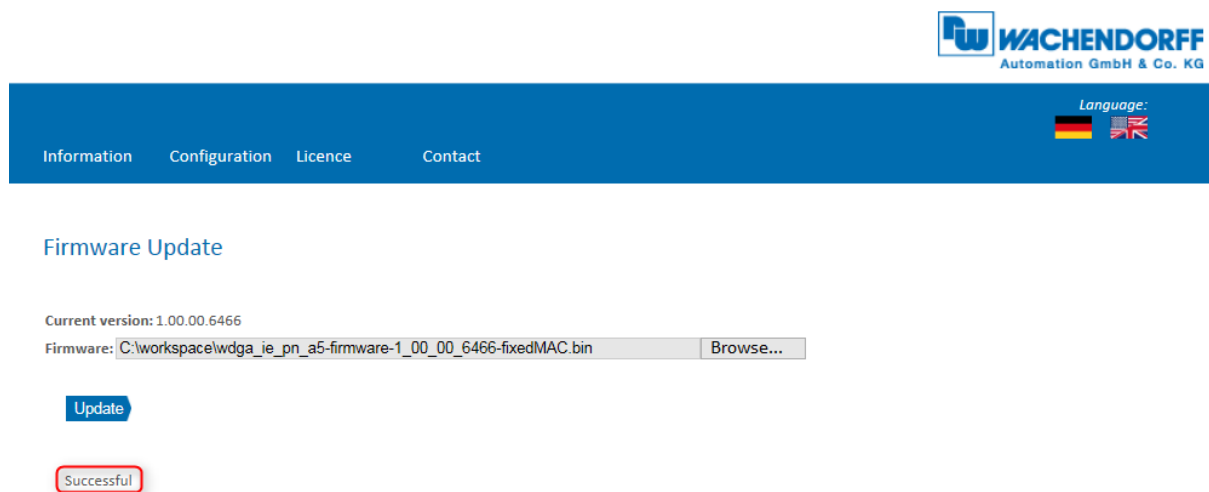

Figure 5.9: Firmware update - Successful



In case of a failure during the firmware update process (see Figure 5.10) please double check that you choose the correct firmware file. Do a power reset and repeat the whole firmware update process. In case of a power loss during the update, the encoder may not respond to any request any more. If this happens, please contact our support team.

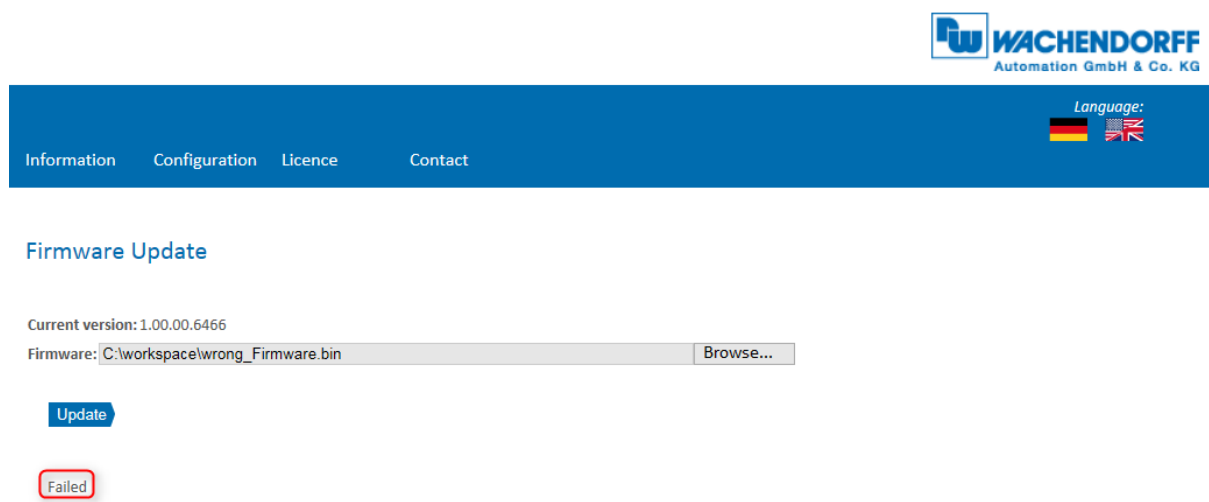

Figure 5.10: Firmware update - Failed

## 5.4 Licence information

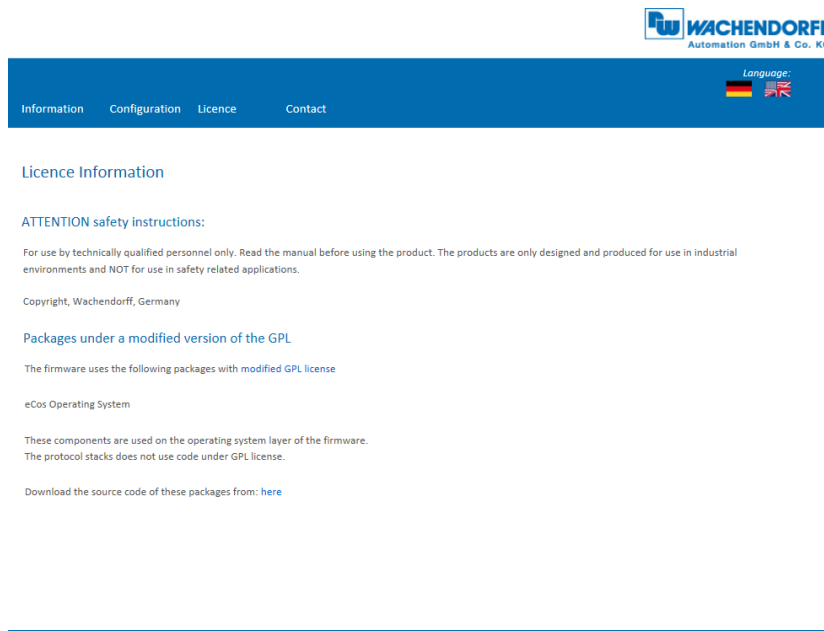

Figure 5.11: Licence information

This view contains the current safety instructions as well as software packages containing firmware. You can download the source code of these packages using the link on this website.

## 5.5 Contact

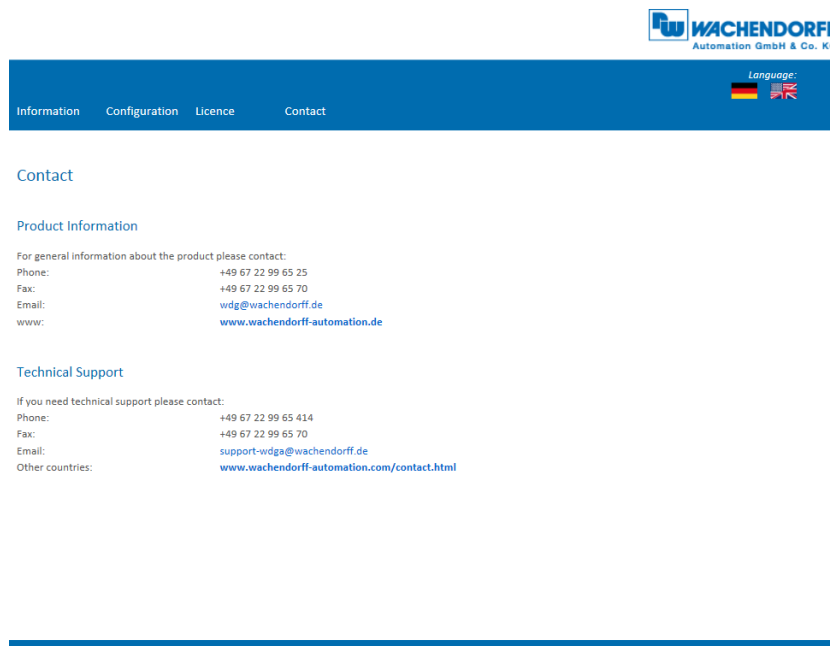

Figure 5.12: Contact information

Contact information for additional product information and technical support is listed here.

## 6 Commissioning

### 6.1 General information

This section contains two configuration examples for Wachendorff Profinet encoders. The first example is shown with version 14 of the TIA portal, the second with Step 7 V5.5 SP4.

### 6.2 Integration into a TIA project

Connect the encoder to your controller.

Connect the encoder's power supply.

To integrate the encoder into your TIA portal project, start your TIA portal, open the required project and switch to the project view by pressing the "Project view" button (see Figure 6.1).

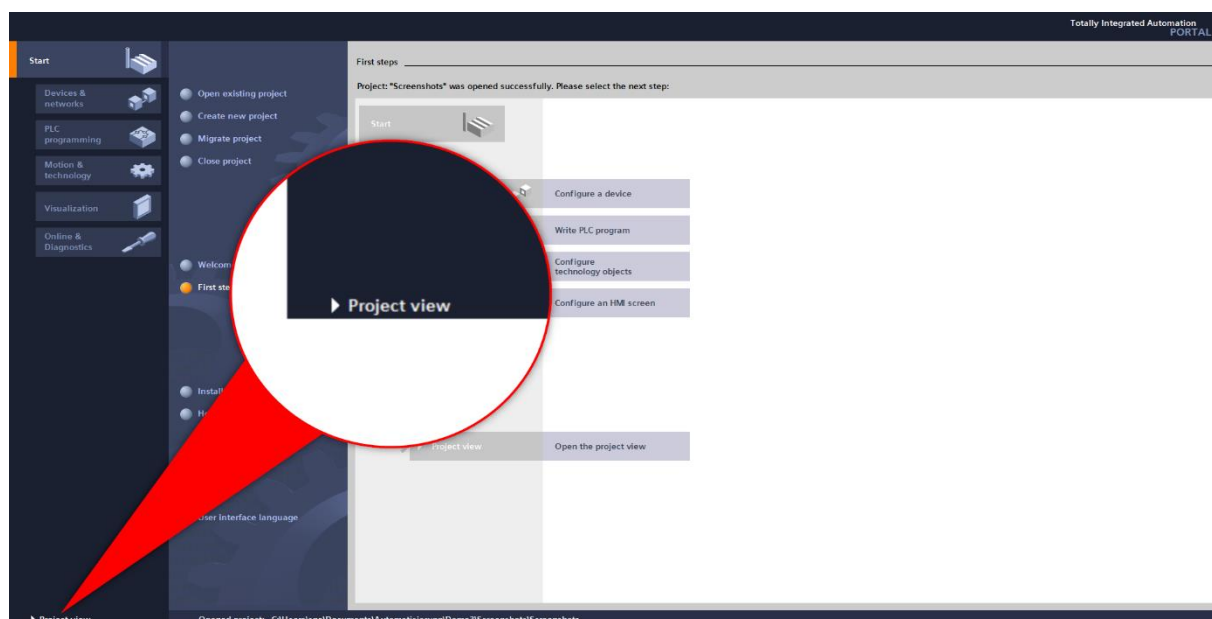



Figure 6.1: Switching to project view

Next, install the GSDML file. You can download these from the download area of our website. To do so, open the "Options" tab and select the menu "Manage general station description files (GSD)" (see Figure 6.2).



- The corresponding .bmp file must be located in the same directory as the GSDML file during installation and is included in the download.

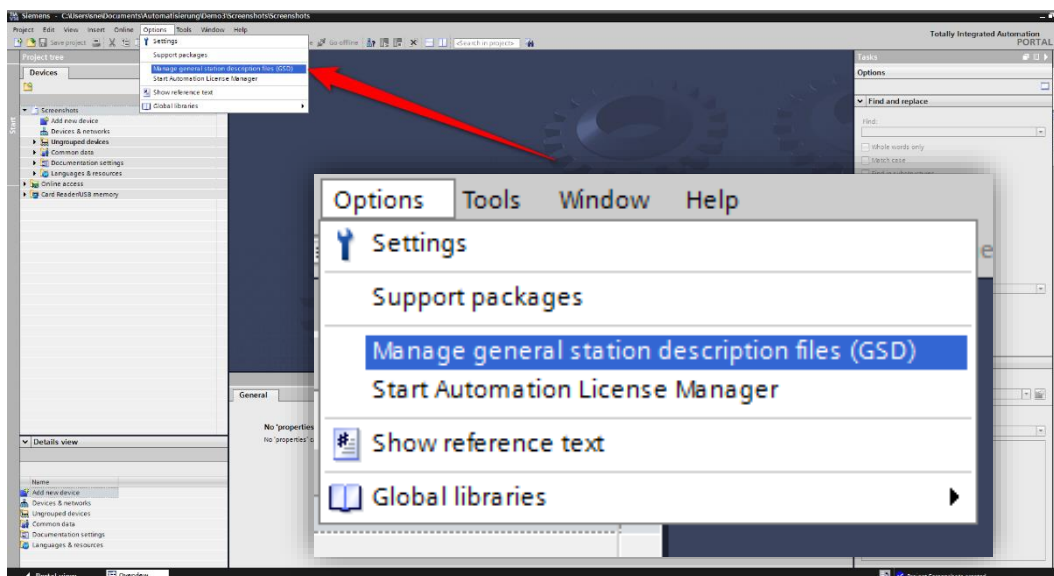

Figure 6.2: Manage device description file (GSD)

Now select the path for the GSDML file, activate the checkmark next to the desired GSDML file and confirm the installation via the "Install" button (see Figure 6.3). Then close the installation window.

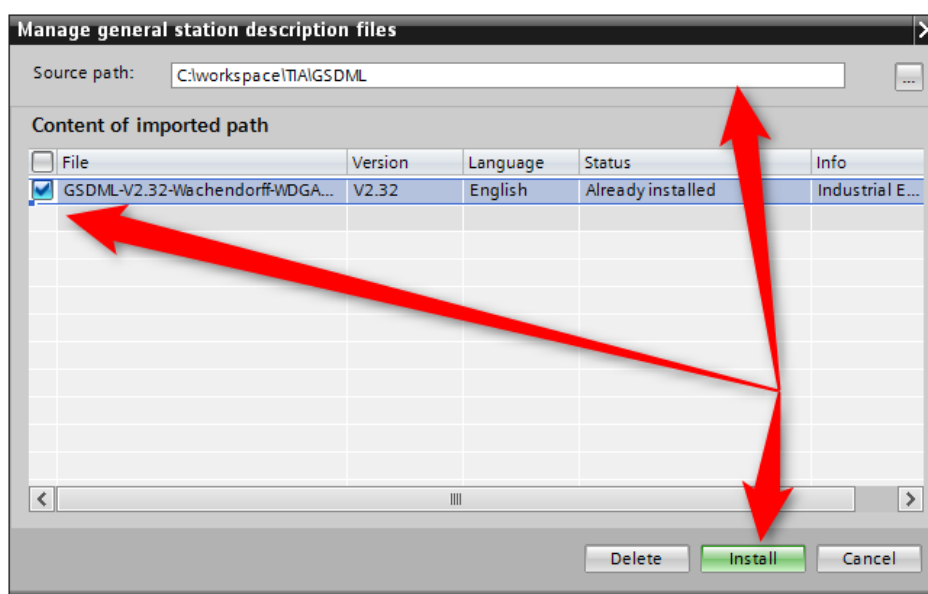

Figure 6.3: Installing GSDML

From the "Project tree" column on the left of the TIA portal, select the "Devices & networks" tab (see Figure 6.4). The hardware view opens and the hardware catalogue is now visible in the right-hand column.

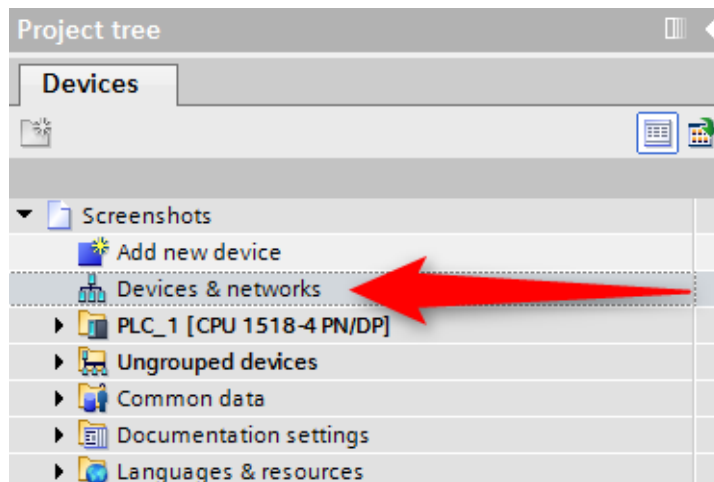

Figure 6.4: Switch to Devices & Networks

Add the encoder to your hardware configuration. To do so, open the following path at the right edge of the screen: "Other field devices / Profinet IO / Encoders / Wachendorff Automation GmbH & Co. KG / WDGA / Wachendorff Encoder" (see Figure 6.5).

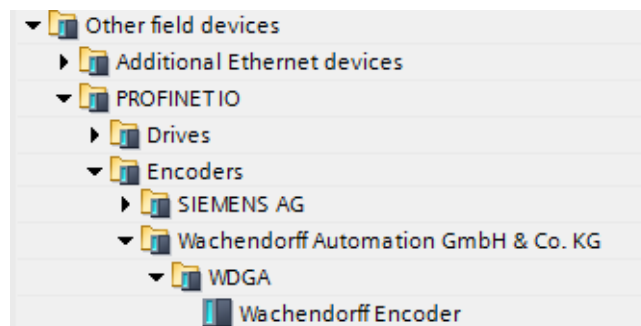

Figure 6.5: Hardware catalogue

Now "drag" the encoder onto the "Profinet IO system". This encoder is now displayed in the hardware view. Connect the encoder to the controller by dragging the encoder port onto the appropriate controller port. The result is shown in Figure 6.6.

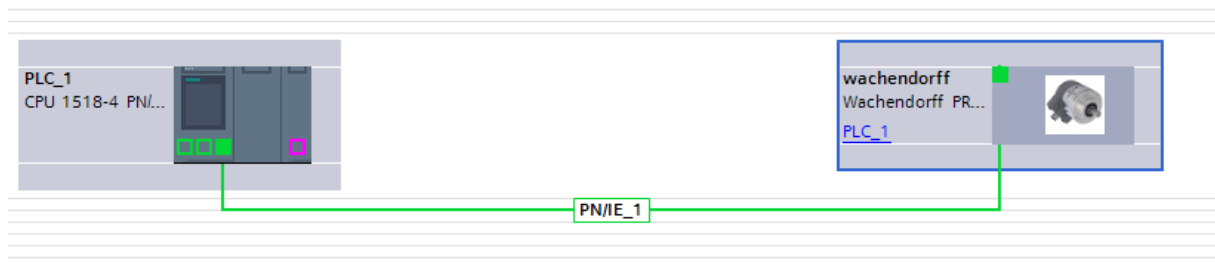

Figure 6.6: Network view

Select the encoder and switch to the "Device overview" tab. Enter a meaningful device name by double-clicking the default name (see Figure 6.7).

Device overview						
Module	Rack	Slot	I address	Q address	Type	
▼ WDGA	0	0			Wachendorff Enco...	
▼ 2 Port PN-IRT-Switch	0	0 X1			WDGA	
Port 1	0	0 X1 P1			Port 1	
Port 2	0	0 X1 P2			Port 2	
	0	1				

Figure 6.7: Change device name

Configure the encoder by selecting the corresponding configuration from the hardware catalogue and dragging it onto "Slot 1" (see Figure 6.8).

Device overview							Catalog	
Module	Rack	Slot	I address	Q address	Type		<Search>	
▼ WDGA	0	0			Wachendorff Enco...		Filter Profile: <All>	
▶ 2 Port PN-IRT-Switch	0	0 X1			WDGA		<ul style="list-style-type: none"> <li>▶ Head module</li> <li>▶ Module                             <ul style="list-style-type: none"> <li>▶ Multiturn                                     <ul style="list-style-type: none"> <li>Multiturn 14 Bit + Singleturn 13 Bit = 27 Bit overall</li> <li>Multiturn 14 Bit + Singleturn 16 Bit = 30 Bit overall</li> <li>Multiturn 16 Bit + Singleturn 16 Bit = 32 Bit overall</li> <li>Multiturn 39 Bit + Singleturn 16 Bit = 55 Bit overall</li> </ul> </li> <li>▶ Singleturn</li> </ul> </li> </ul>	

Figure 6.8: Select module

	<ul style="list-style-type: none"> <li>• If a singleturn encoder is accidentally configured as a multiturn encoder, the STAT LED of the encoder will flash red after starting the CPU.</li> <li>• This indicates a configuration error, as a singleturn encoder cannot output multiturn data.</li> <li>• In this case, please select the appropriate singleturn module.</li> </ul>
--	--

Now select the desired telegram for communication. To do so, proceed as in the previous step. Select "Slot 1 2". The various telegrams can be found under "Profile" in the "Submodules" tab (see Figure 6.9).

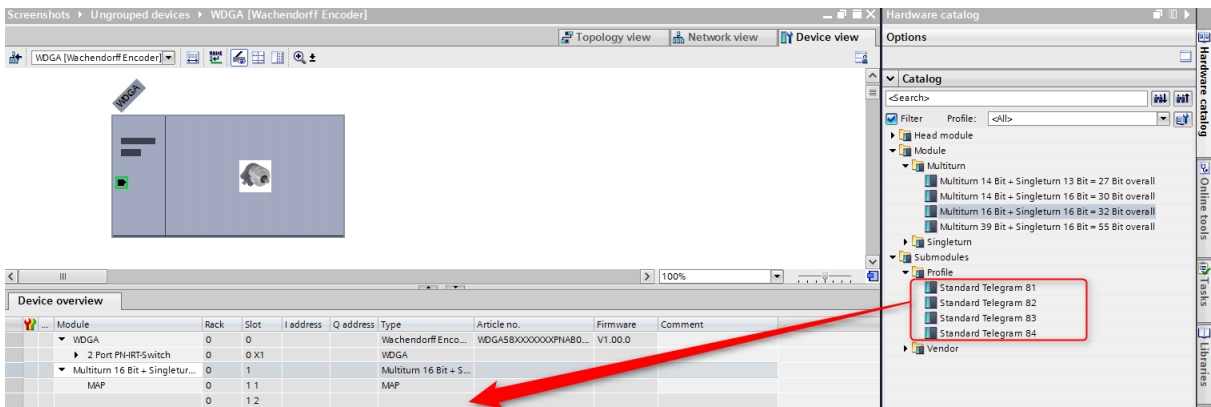

Figure 6.9: Select telegram

You can also set the corresponding I/O addresses. To do so, double-click on the respective field and change the address (see Figure 6.10).

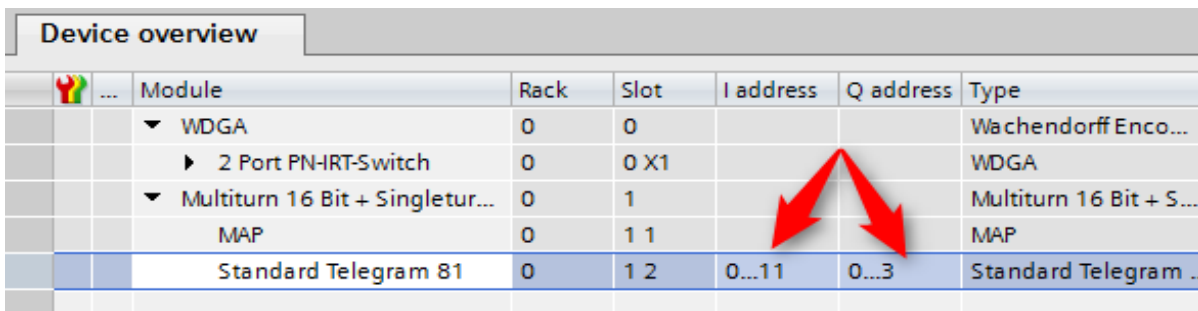

Figure 6.10: Change the I/O addresses

Click on your PLC in the project navigation window and load the configuration by clicking the "Download to device" button (see Figure 6.11).

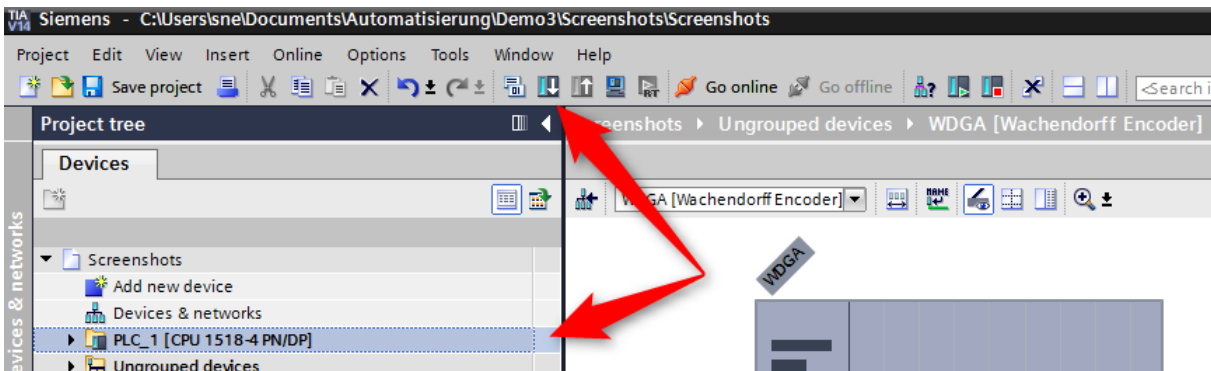

Figure 6.11: Download to device

Switch back to the "Devices and networks" view and assign the Profinet device name to the encoder as shown in the configuration on page 39. To do so, select the encoder (single mouse click) and select the "Assign device name" option (see Figure 6.12).

Assign a name to the encoder. Then select your PG/PC interface and the type and click on "Update list" (see Figure 6.13).

All devices are now displayed under "Accessible devices in the network". Select your encoder and click on "Assign name" (see Figure 6.14).

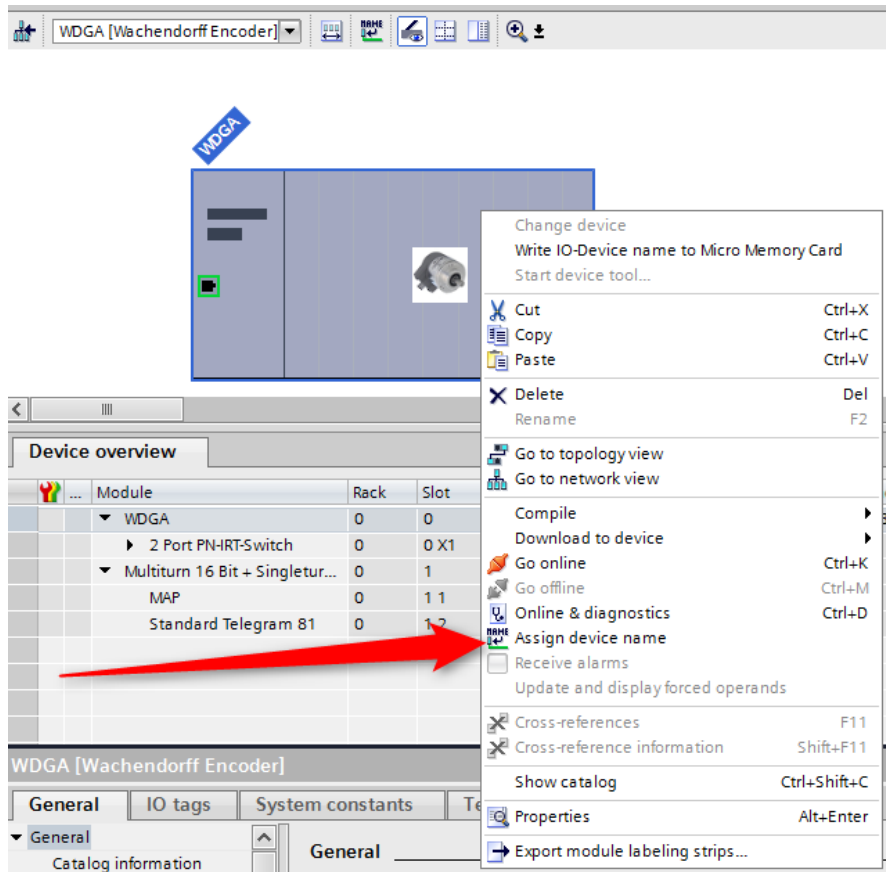

Figure 6.12: Assigning device names

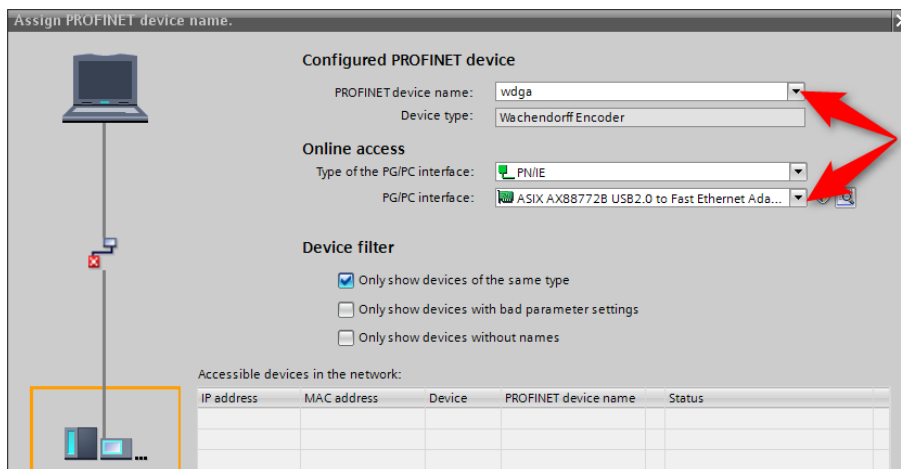

Figure 6.13: Name and PG interface



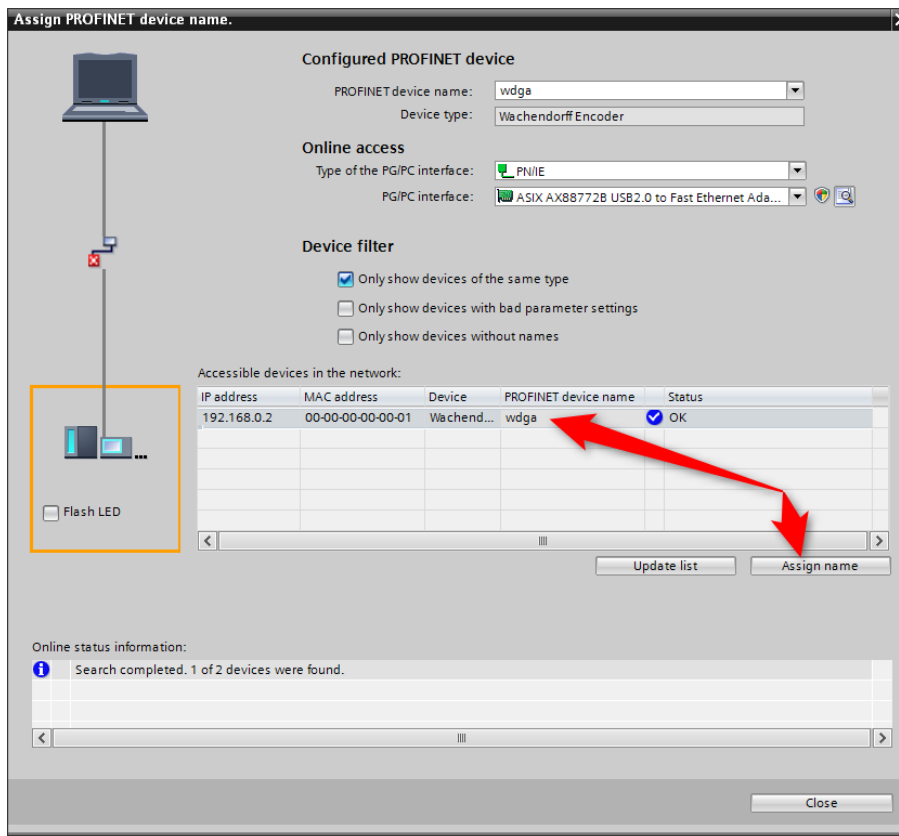

Figure 6.14: Accessible nodes

You will now see the successfully assigned name in the online status information. Click on "close" (see Figure 6.15).

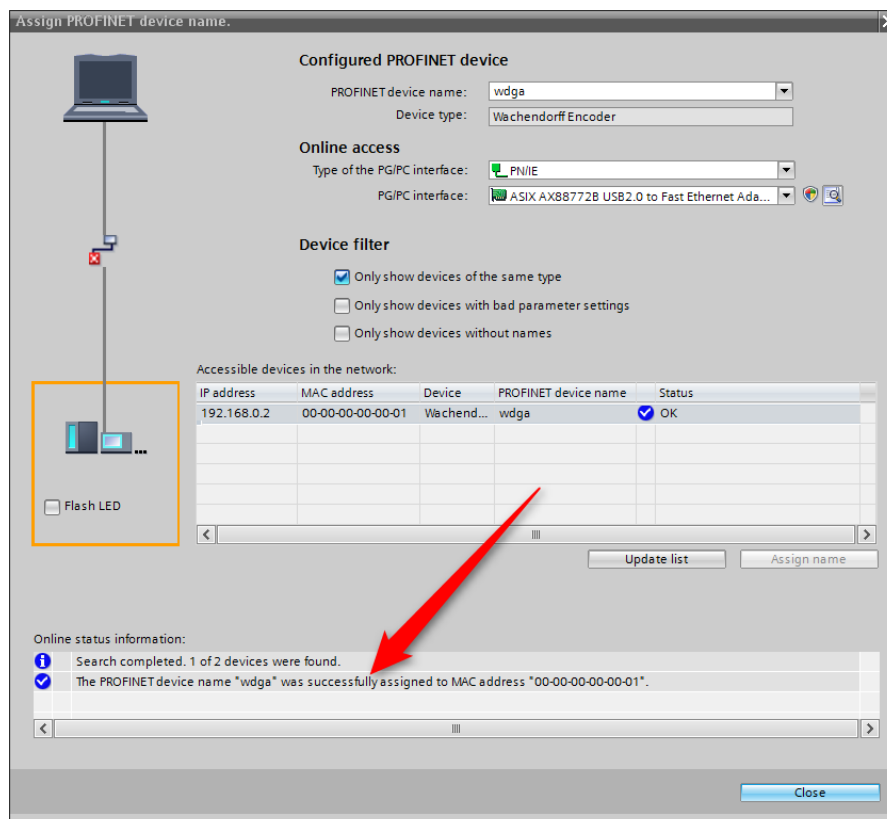

Figure 6.15: Online status information

You can use a variable table to display the encoder's I/O data for test purposes. To do so, open the default tag table (see Figure 6.16) and enter the corresponding address for the position value. You can then click on "Show all" to see the position value (see Figure 6.17 and Figure 6.18).

Example:

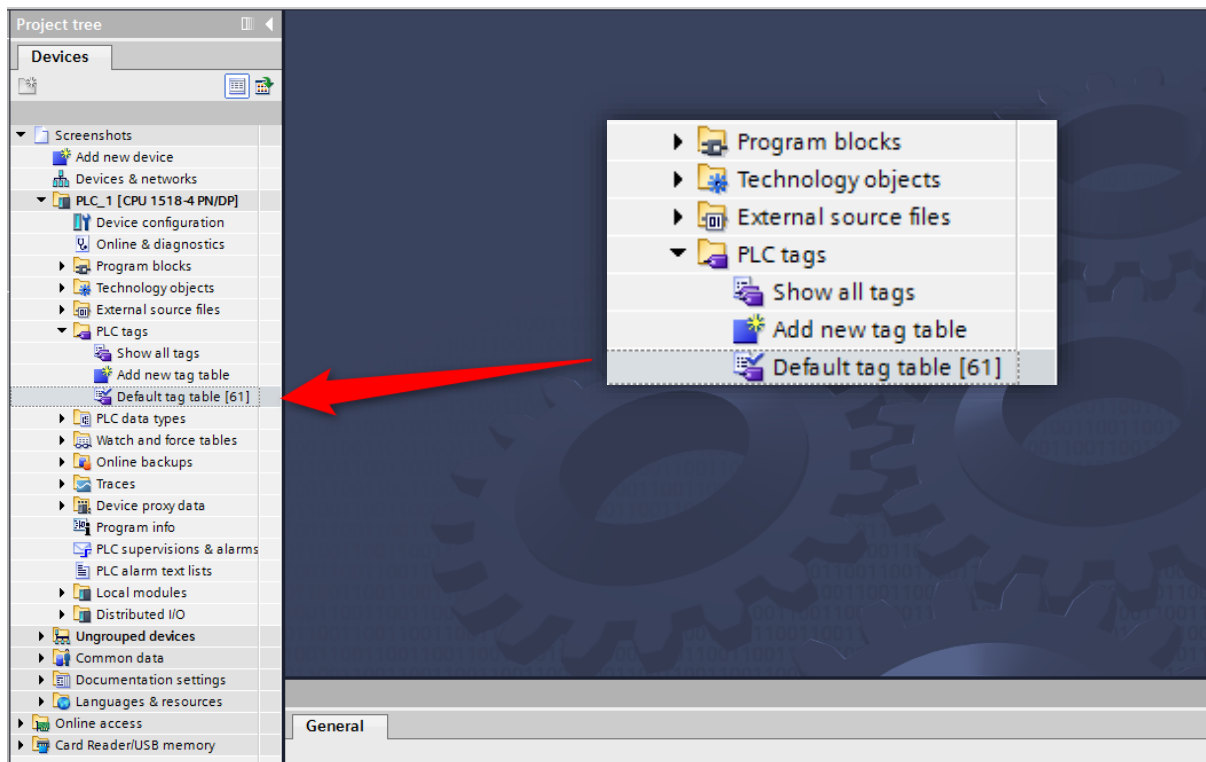

Figure 6.16: PLC variables

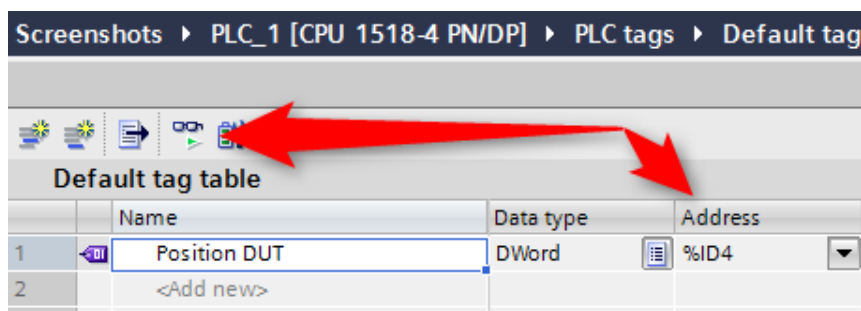

Figure 6.17: Show all

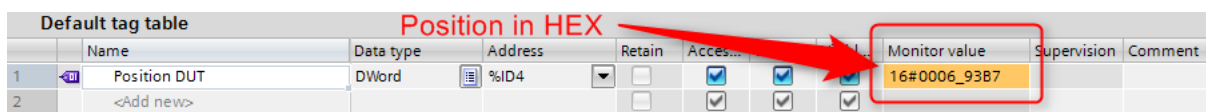

Figure 6.18: Default tag table

## 6.3 Scaling function

In order to set a different number of steps / revolutions or revolutions than the one given in the GSDML file, the scaling function must be activated. The following two examples explain this for a singleturn and a multiturn encoder. It is assumed that you have already configured the encoder and your PLC in the TIA portal.

### 6.3.1 Example scaling function singleturn 16-bit to 12-bit

Double-click on the image of the encoder in the network view of "Devices and Networks". (s. Figure 6.19)

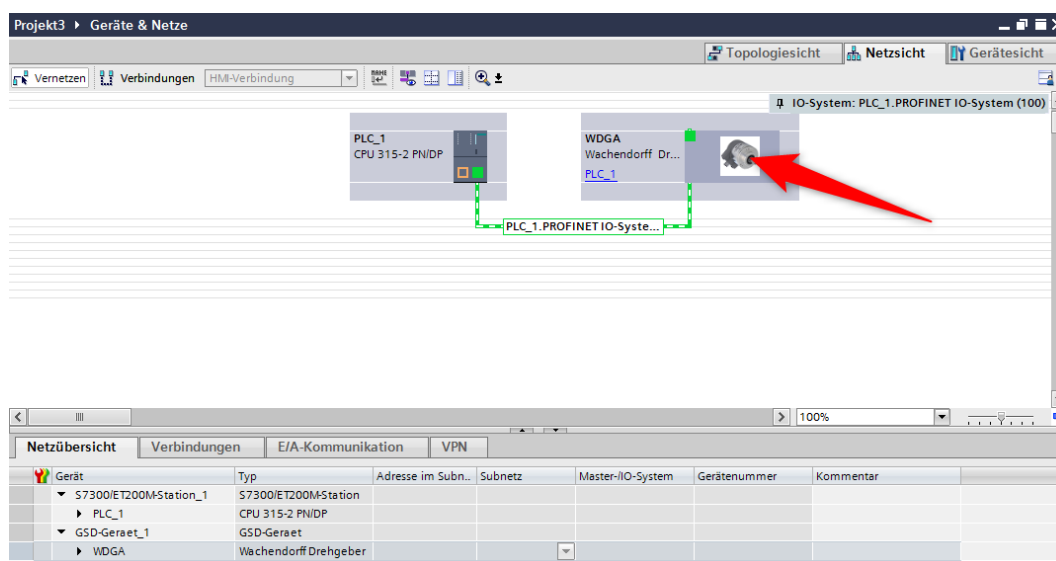

Figure 6.19: Example of commissioning

Figure 6.20 now shows a rotary encoder configured as 16-bit singleturn. In the "Device overview" we click on the field "MAP".

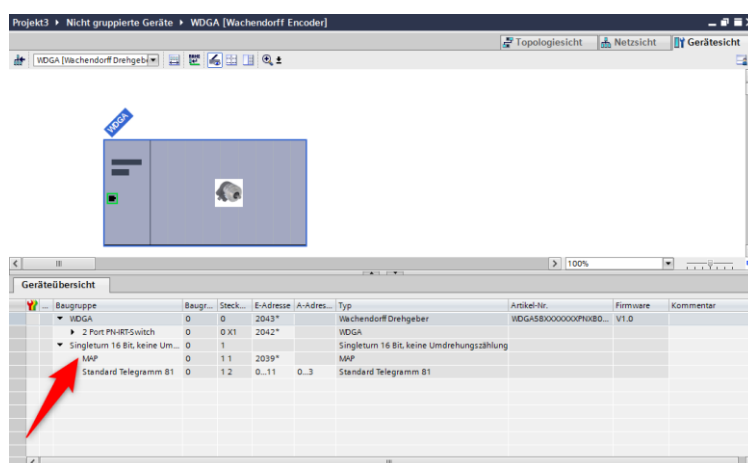

Figure 6.20: Device overview - MAP

The "Assembly parameters" which we click on will then appear in the "Properties" under "Device overview" in the "General" tab. (s. Figure 6.21)

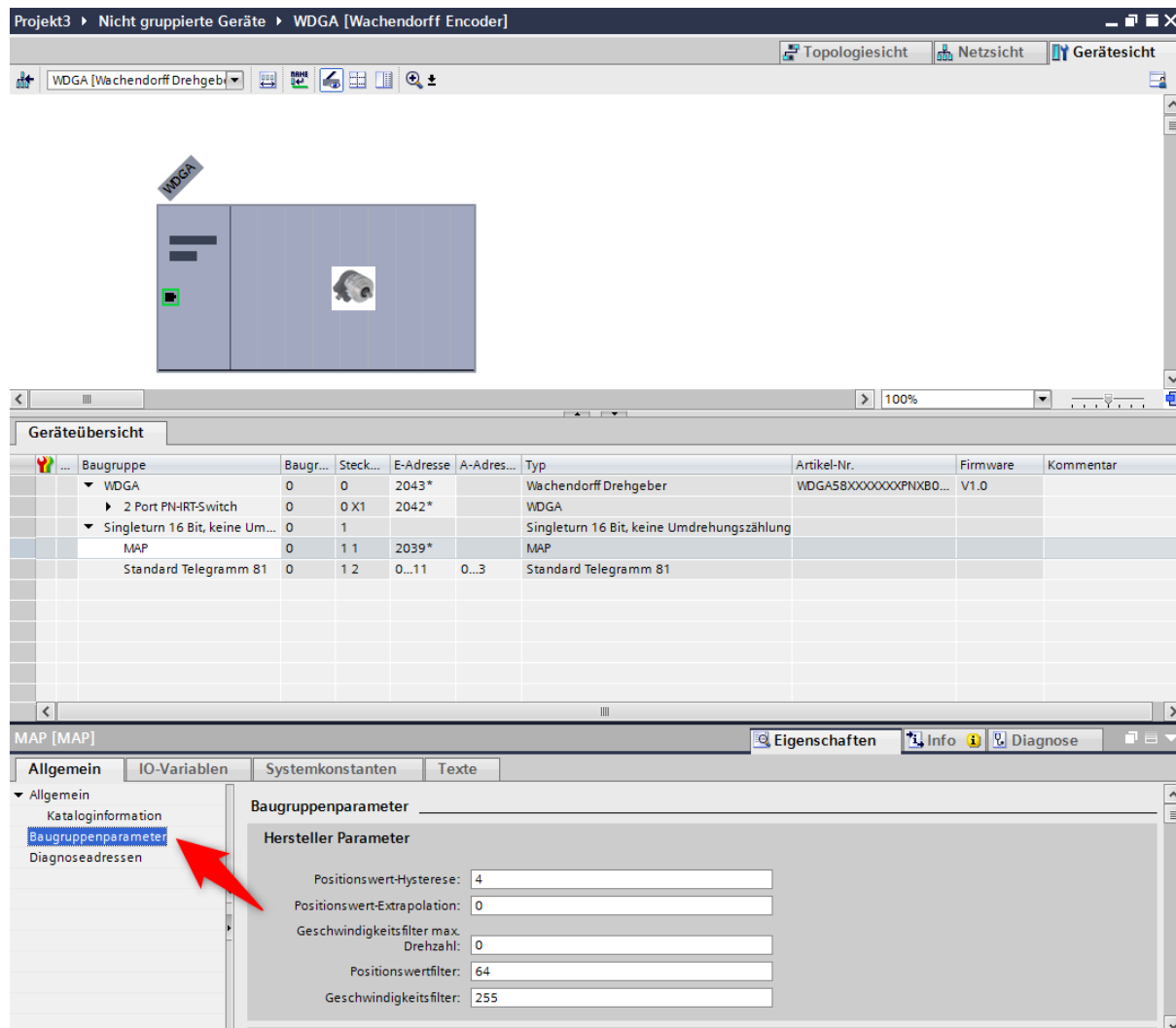

Figure 6.21: Assembly parameters

The default settings of the 16-bit singleturn encoder are shown in Figure 6.22.

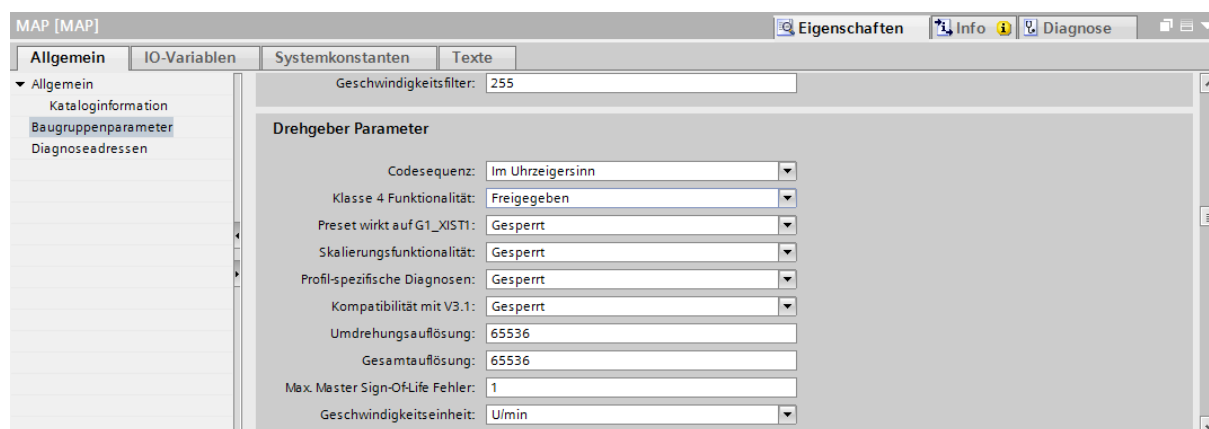

Figure 6.22: Default assembly parameters 16-Bit Singleturn

In this example we want to set a resolution of 12-bit. To do this, turn on the scaling function by setting it to "Enabled". In the fields "Rotation resolution" and "Total resolution", enter the value for 12-Bit ( $2^{12} = 4096$ ). (s. Figure 6.23)

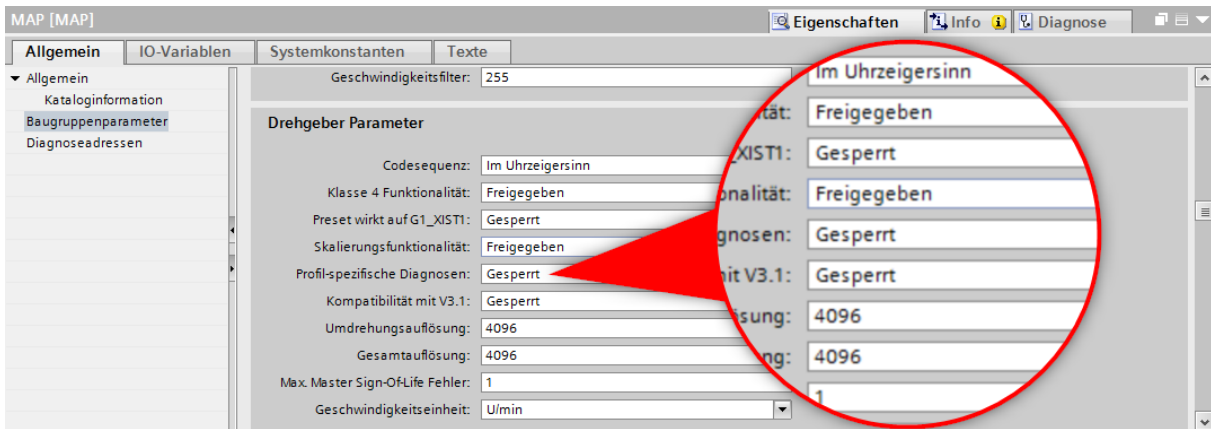



Figure 6.23: Configuration of 12-Bit Singleturn with scaling



- If a new project is created and the scaling function is set up, a "Load into device" is sufficient to activate this function.
- If an existing project is changed in order to add the scaling function, the change must be transferred to the controller with "Load into device" -> "Hardware configuration".

### 6.3.2 Example scaling function multiturn

Double-click on the image of the encoder in the network view of "Devices and Networks". (s. Figure 6.24)

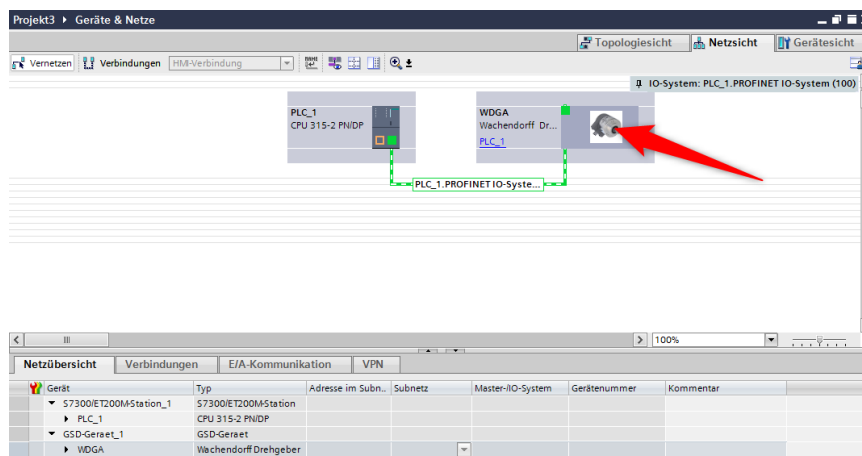

Figure 6.24: Example of commissioning

Figure 6.25 now shows a rotary encoder configured as 16-bit singleturn and 43-bit multiturn. In the "Device overview" we click on the field "MAP".

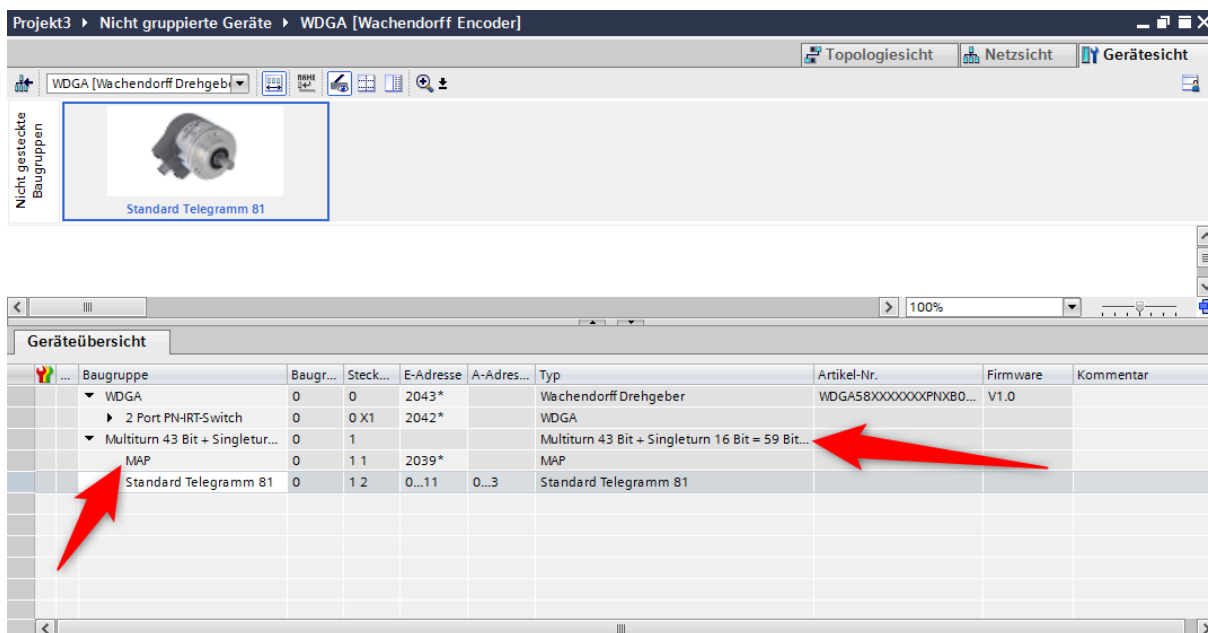

Figure 6.25: Device overview - MAP

The "Assembly parameters" which we click on will then appear in the "Properties" under "Device overview" in the "General" tab. (s. Figure 6.26)

Here you can also see the default settings of a 43-bit multiturn and 16-bit singleturn encoder.

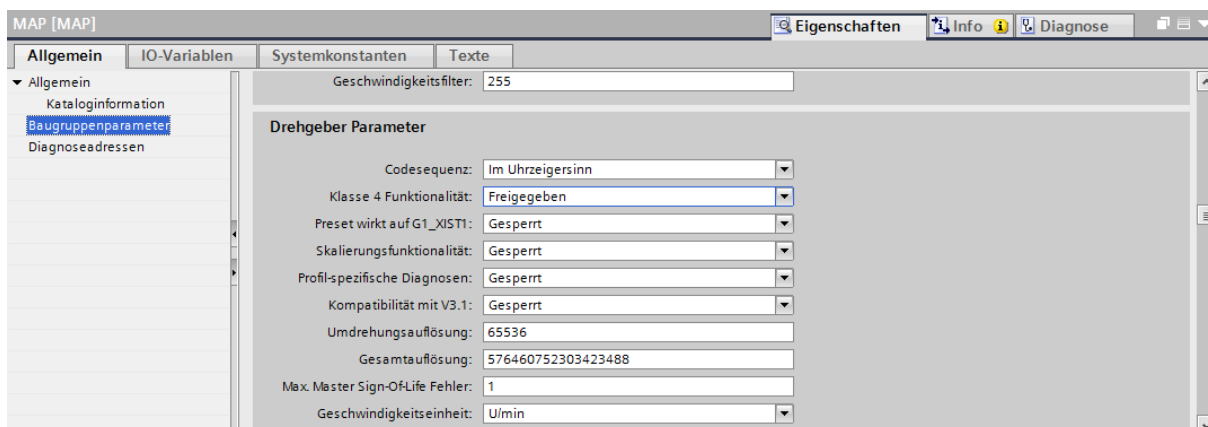

Figure 6.26: Assembly parameters

In this example we want to set a resolution of 360 steps/revolution and 10 countable revolutions (10 x 360 steps = 3600 steps total resolution).

To do this, turn on the scaling function by setting it to "Enabled". Enter 360 in the field "Revolution resolution" and 3600 in the field "Total resolution". (s. Figure 6.27)

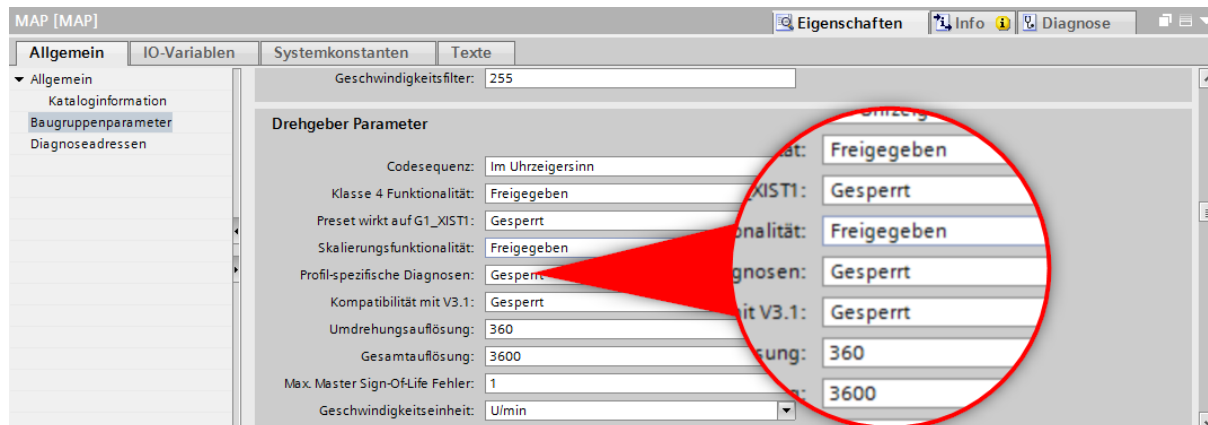



Figure 6.27: Configuration of 360 Steps/revolution and 10 revolutions



- If a new project is created and the scaling function is set up, a "Load into device" is sufficient to activate this function.
- If an existing project is changed in order to add the scaling function, the change must be transferred to the controller with "Load into device" -> "Hardware configuration".

### 6.3.3 Executing a preset

First set whether the preset should also act on G1\_XIST1. For the following explanations it is assumed that telegram 81 is used and that the input data (from the view of the controller) are present at input addresses 0...11 and the output data at output addresses 0...3. In this case the following data contents exist:

Data	Type		Adress	Adressing
STW2_ENC	W	Encoder control word	Q0..Q1	QW0
G1_STW	W	Axis control word	Q2..Q3	QW2
ZSW2_ENC	W	Status word of the encoder	I0..I1	IW0
G1_ZSW	W	Status word of the axis	I2..I3	IW2
G1_XIST1	DW	Processdata	I4..I7	ID4
G1_XIST2	DW	Processdata or error register	I8..I11	ID8

Table 6.1: Data content for Example

Set the encoder to normal, controlled operation during startup or manually via an observation table. To do this, set STW2\_ENC bit 10 "Control by PLC" to TRUE.

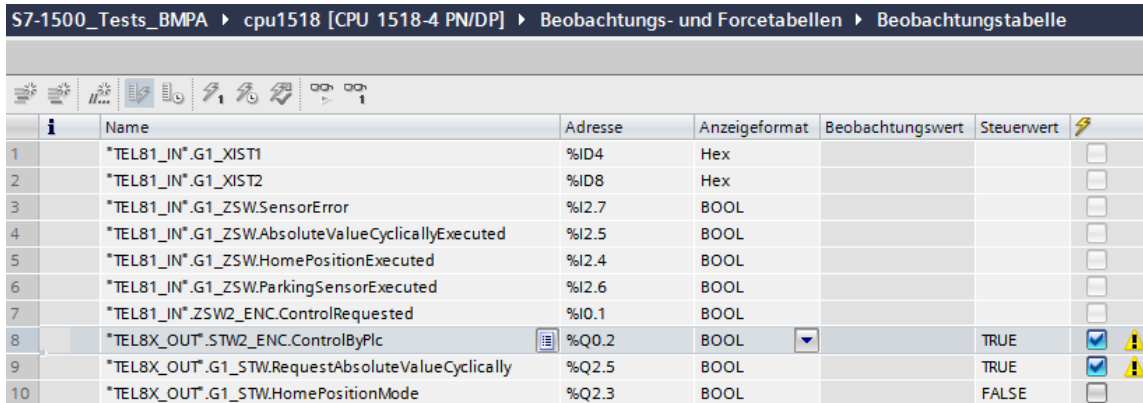



	Name	Adresse	Anzeigeformat	Beobachtungswert	Steuerwert	
1	*TEL81_IN*.G1_XIST1	%ID4	Hex			<input type="checkbox"/>
2	*TEL81_IN*.G1_XIST2	%ID8	Hex			<input type="checkbox"/>
3	*TEL81_IN*.G1_ZSW.SensorError	%I2.7	BOOL			<input type="checkbox"/>
4	*TEL81_IN*.G1_ZSW.AbsoluteValueCyclicallyExecuted	%I2.5	BOOL			<input type="checkbox"/>
5	*TEL81_IN*.G1_ZSW.HomePositionExecuted	%I2.4	BOOL			<input type="checkbox"/>
6	*TEL81_IN*.G1_ZSW.ParkingSensorExecuted	%I2.6	BOOL			<input type="checkbox"/>
7	*TEL81_IN*.ZSW2_ENC.ControlRequested	%I0.1	BOOL			<input type="checkbox"/>
8	*TEL8X_OUT*.STW2_ENC.ControlByPlc	%Q0.2	BOOL		TRUE	<input checked="" type="checkbox"/> 
9	*TEL8X_OUT*.G1_STW.RequestAbsoluteValueCyclically	%Q2.5	BOOL		TRUE	<input checked="" type="checkbox"/> 
10	*TEL8X_OUT*.G1_STW.HomePositionMode	%Q2.3	BOOL		FALSE	<input type="checkbox"/>

Figure 6.28: set STW2\_ENC bit 10 to TRUE

If successful, the encoder sets the flag ZSW2\_ENC Bit 9 "Control requested". Then set G1\_STW bit 13 "Request absolute value cyclically" to TRUE.



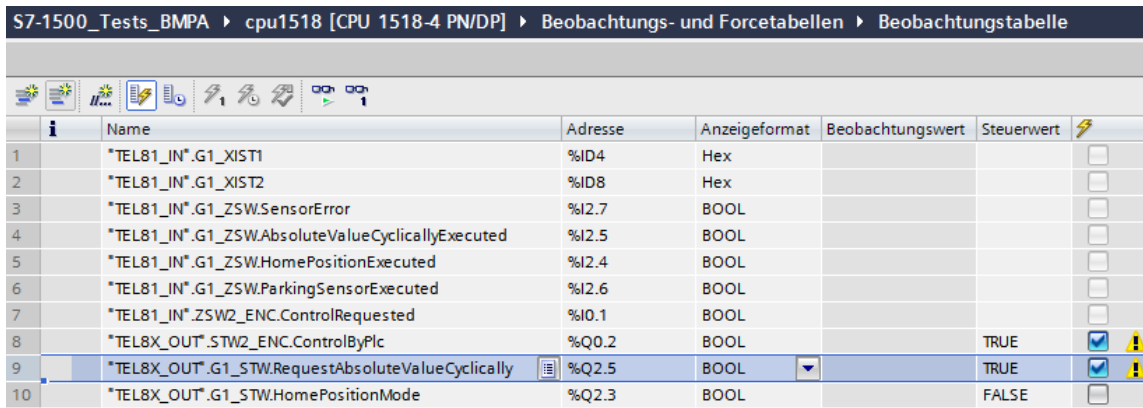

	Name	Adresse	Anzeigeformat	Beobachtungswert	Steuerwert	
1	*TEL81_IN*.G1_XIST1	%ID4	Hex			<input type="checkbox"/>
2	*TEL81_IN*.G1_XIST2	%ID8	Hex			<input type="checkbox"/>
3	*TEL81_IN*.G1_ZSW.SensorError	%I2.7	BOOL			<input type="checkbox"/>
4	*TEL81_IN*.G1_ZSW.AbsoluteValueCyclicallyExecuted	%I2.5	BOOL			<input type="checkbox"/>
5	*TEL81_IN*.G1_ZSW.HomePositionExecuted	%I2.4	BOOL			<input type="checkbox"/>
6	*TEL81_IN*.G1_ZSW.ParkingSensorExecuted	%I2.6	BOOL			<input type="checkbox"/>
7	*TEL81_IN*.ZSW2_ENC.ControlRequested	%I0.1	BOOL			<input type="checkbox"/>
8	*TEL8X_OUT*.STW2_ENC.ControlByPlc	%Q0.2	BOOL		TRUE	<input checked="" type="checkbox"/> 
9	*TEL8X_OUT*.G1_STW.RequestAbsoluteValueCyclically	%Q2.5	BOOL		TRUE	<input checked="" type="checkbox"/> 
10	*TEL8X_OUT*.G1_STW.HomePositionMode	%Q2.3	BOOL		FALSE	<input type="checkbox"/>

Figure 6.29: set G1\_STW bit 13 to TRUE

If successful, the encoder sets the flag G1\_ZSW Bit 13 "Transmit absolute value cyclically" and G1\_XIST2 contains the same value as G1\_XIST1.

Finally, you can select the preset mode via G1\_STW Bit 11 "Home position mode" (default 0 = absolute, 1 = relative).



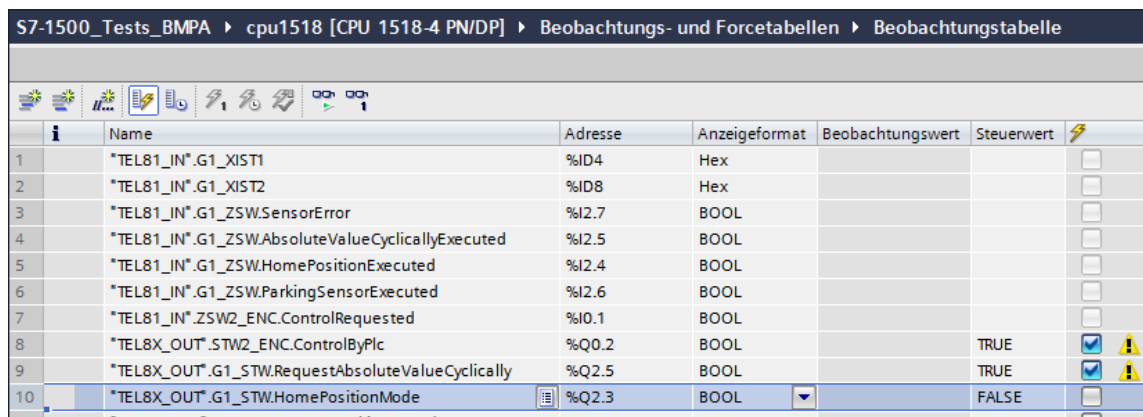

	Name	Adresse	Anzeigeformat	Beobachtungswert	Steuerwert	
1	*TEL81_IN*.G1_XIST1	%ID4	Hex			<input type="checkbox"/>
2	*TEL81_IN*.G1_XIST2	%ID8	Hex			<input type="checkbox"/>
3	*TEL81_IN*.G1_ZSW.SensorError	%I2.7	BOOL			<input type="checkbox"/>
4	*TEL81_IN*.G1_ZSW.AbsoluteValueCyclicallyExecuted	%I2.5	BOOL			<input type="checkbox"/>
5	*TEL81_IN*.G1_ZSW.HomePositionExecuted	%I2.4	BOOL			<input type="checkbox"/>
6	*TEL81_IN*.G1_ZSW.ParkingSensorExecuted	%I2.6	BOOL			<input type="checkbox"/>
7	*TEL81_IN*.ZSW2_ENC.ControlRequested	%I0.1	BOOL			<input type="checkbox"/>
8	*TEL8X_OUT*.STW2_ENC.ControlByPlc	%Q0.2	BOOL		TRUE	<input checked="" type="checkbox"/> 
9	*TEL8X_OUT*.G1_STW.RequestAbsoluteValueCyclically	%Q2.5	BOOL		TRUE	<input checked="" type="checkbox"/> 
10	*TEL8X_OUT*.G1_STW.HomePositionMode	%Q2.3	BOOL		FALSE	<input type="checkbox"/>

Figure 6.30: G1\_STW Bit 11 default 0 = absolute



The preset to the pre-defined preset value (0 by default, adjustable via PNU 65000 or PNU 65002) can now be executed with a pulse to G1\_STW Bit 12 "Request of home position" (set and reset).



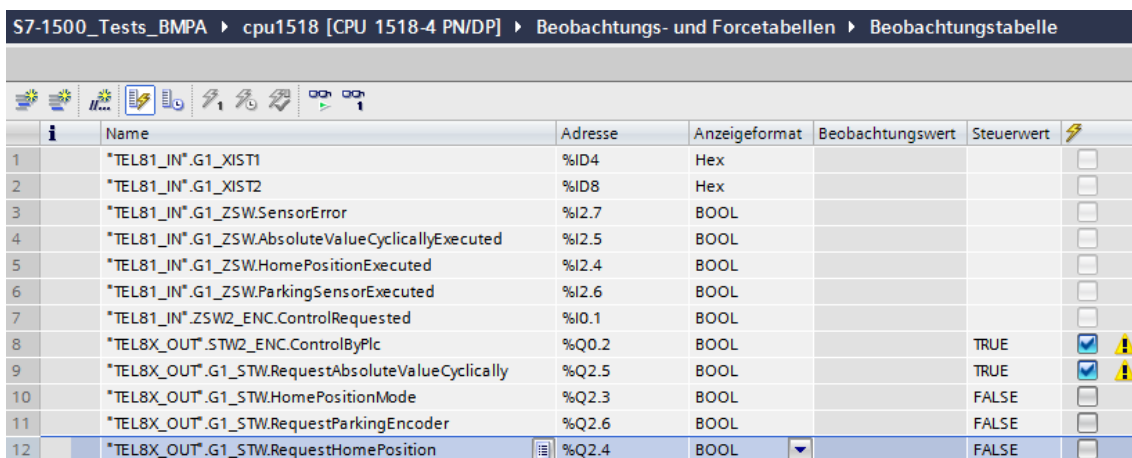



	Name	Adresse	Anzeigeformat	Beobachtungswert	Steuerwert	
1	*TEL81_IN*.G1_XIST1	%ID4	Hex			<input type="checkbox"/>
2	*TEL81_IN*.G1_XIST2	%ID8	Hex			<input type="checkbox"/>
3	*TEL81_IN*.G1_ZSW.SensorError	%I2.7	BOOL			<input type="checkbox"/>
4	*TEL81_IN*.G1_ZSW.AbsoluteValueCyclicallyExecuted	%I2.5	BOOL			<input type="checkbox"/>
5	*TEL81_IN*.G1_ZSW.HomePositionExecuted	%I2.4	BOOL			<input type="checkbox"/>
6	*TEL81_IN*.G1_ZSW.ParkingSensorExecuted	%I2.6	BOOL			<input type="checkbox"/>
7	*TEL81_IN*.ZSW2_ENC.ControlRequested	%I0.1	BOOL			<input type="checkbox"/>
8	*TEL8X_OUT*.STW2_ENC.ControlByPlc	%Q0.2	BOOL		TRUE	<input checked="" type="checkbox"/> 
9	*TEL8X_OUT*.G1_STW.RequestAbsoluteValueCyclically	%Q2.5	BOOL		TRUE	<input checked="" type="checkbox"/> 
10	*TEL8X_OUT*.G1_STW.HomePositionMode	%Q2.3	BOOL		FALSE	<input type="checkbox"/>
11	*TEL8X_OUT*.G1_STW.RequestParkingEncoder	%Q2.6	BOOL		FALSE	<input type="checkbox"/>
12	*TEL8X_OUT*.G1_STW.RequestHomePosition	%Q2.4	BOOL		FALSE	<input type="checkbox"/>

Figure 6.31: set and reset G1\_STW Bit 12

G1\_XIST2 then contains the pre-defined preset value. If "Preset affects G1\_XIST1", this also applies to G1\_XIST1.



- When the preset is executed, an offset value is calculated and stored in the rotary encoder. This value is loaded with each reset so that this setting is retained even after a reset. The offset value is reset as soon as the scaling of the encoder changes or another module is selected. This ensures that an offset value is not used that may not match the set scaling.



- The preset is executed by the encoder on a rising edge to G1\_STW bit 12; it is confirmed on the following falling edge. Only then the preset can be executed again.

### 6.3.4 Resetting a preset

To undo or reset the preset, simply set the preset with the preset value 0 and G1\_STW bit 11 "Home position mode" to 1 = relative. This sets the internal offset value to 0.

## 6.4 Integration into a Step 7 project

Connect the encoder to your controller.

Connect the encoder's power supply.

To integrate the encoder into your SIMATIC Manager project, double-click the "Hardware" button to start the hardware configuration tool (see Figure 6.32).

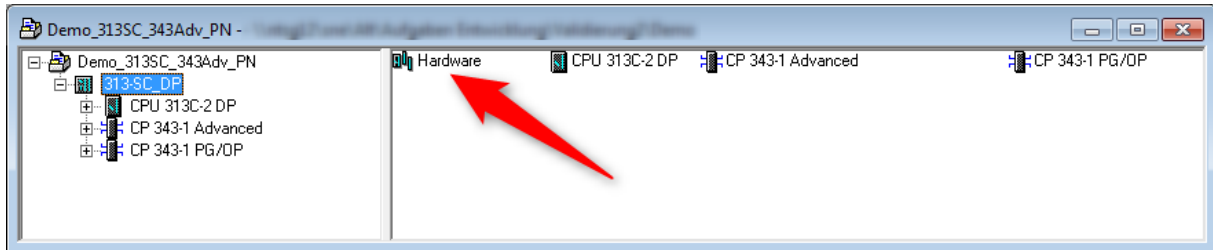

Figure 6.32: SIMATIC Manager

Next, install the GSDML file. You can download this from [www.wachendorff-automation.de](http://www.wachendorff-automation.de). To do so, open the "Extras" tab and select "Install GSD file" (see Figure 6.33).

	<ul style="list-style-type: none"><li>• The corresponding .bmp file must be located in the same directory as the GSDML file during installation and is included in the download.</li></ul>
--	--

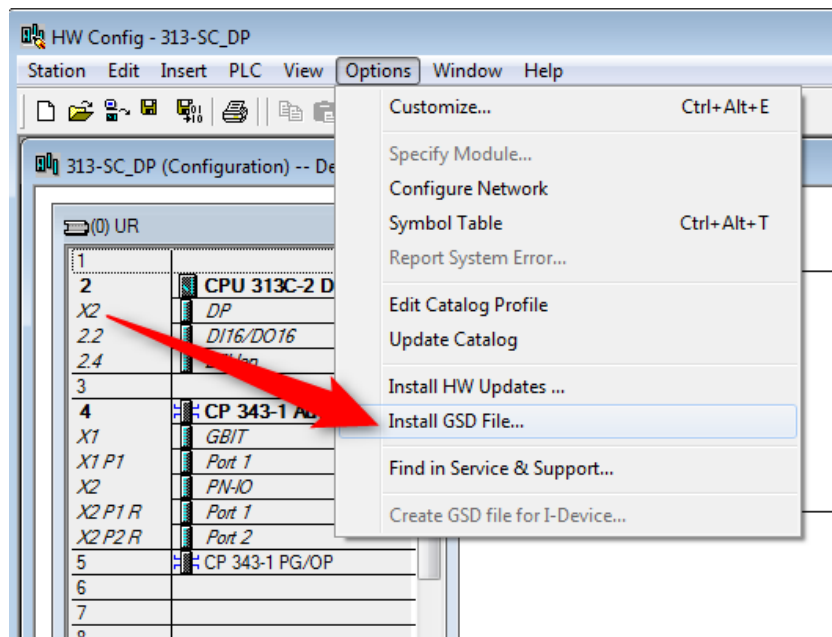

Figure 6.33: Installing the GSDML file

Now select the path for the GSDML file, select the desired GSDML file and confirm the installation via the "Install" button (see Figure 6.34). Then close the installation window.

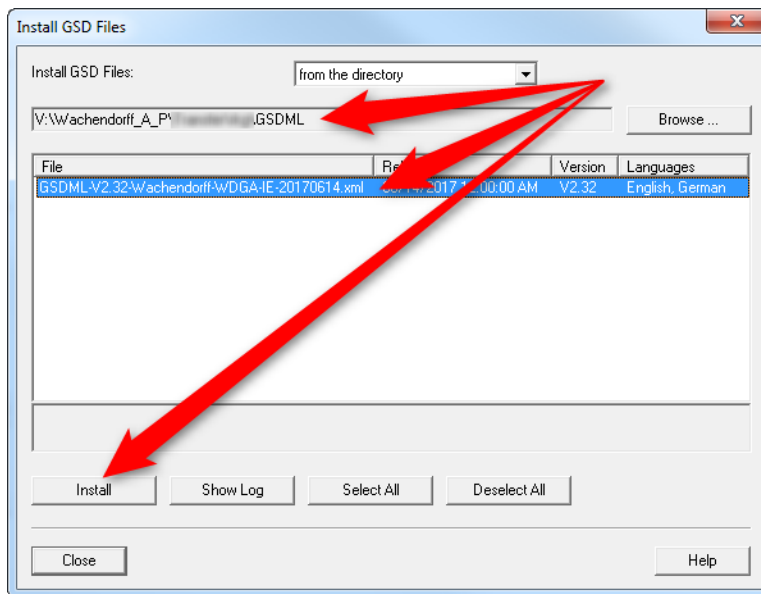

Figure 6.34: Installing GSDML

Add the encoder to your hardware configuration. To do so, open the following path at the right edge of the screen (see Figure 6.35):

"PROFINET IO/Additional Field Devices/Encoders/WDGA/Wachendorff Encoder".

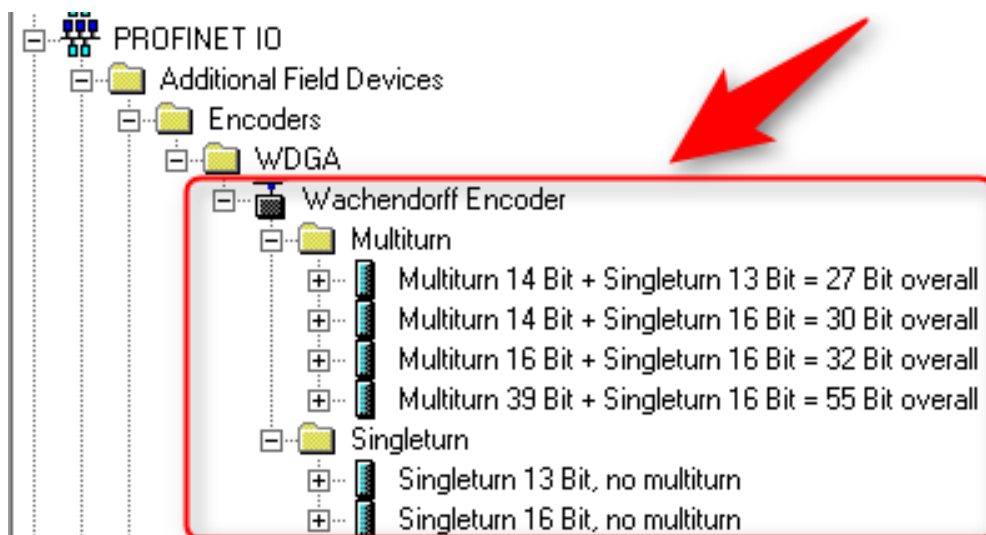

Figure 6.35: Hardware catalogue

Now "drag" the encoder onto the "Profinet IO system". The encoder is then displayed in the hardware view (see Figure 6.36). Enter a meaningful device name for the configured encoder by double-clicking the encoder symbol (see Figure 6.37).

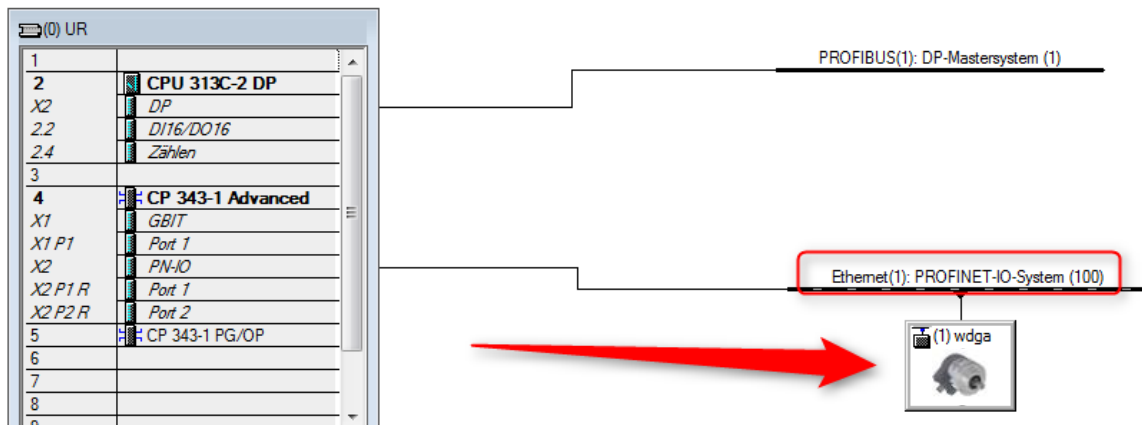

Figure 6.36: Hardware view

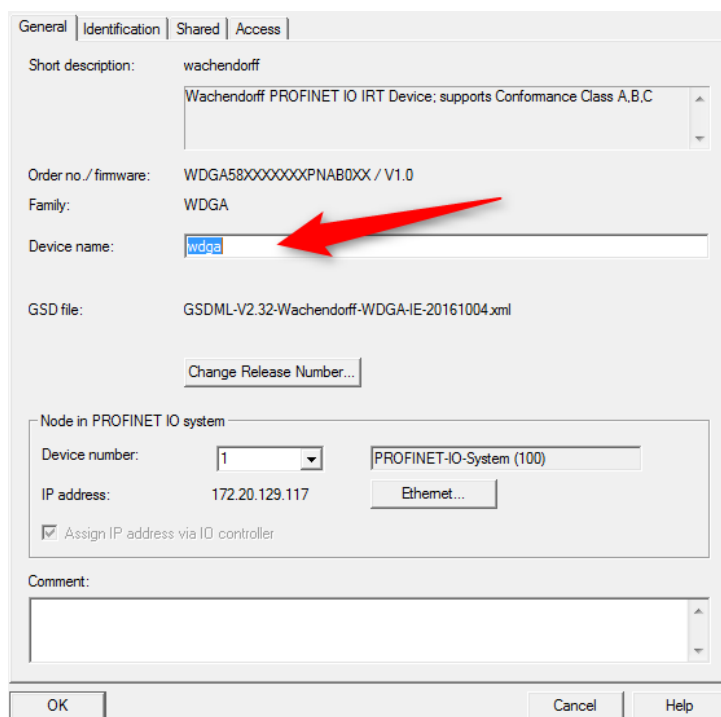

Figure 6.37: Assign a device name

Now select the encoder's "Properties". To do this, single-click on the encoder (see Figure 6.38) and drag the desired properties (see Figure 6.39 No. 1) via drag-and-drop from the hardware catalogue to "Slot 1", which is now highlighted green (see Figure 6.40). Select the desired telegram for communication (see Figure 6.39 No. 2). The various telegrams can be found in the "Profiles" sub-menu. Drag the telegram to slot 1.2 (see Figure 6.41).

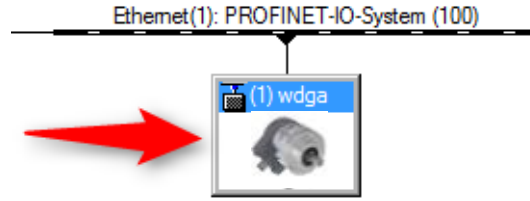

Figure 6.38: Select via single mouse click

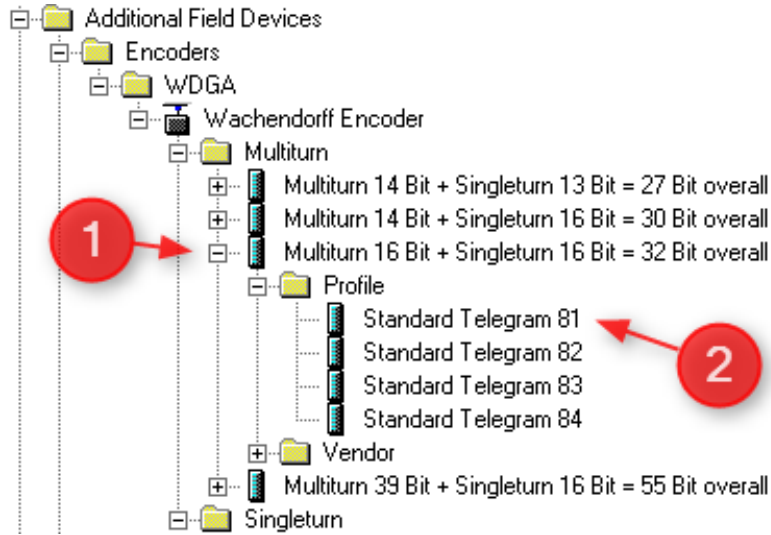

Figure 6.39: Select the properties and the telegram

← → (1) WDGA

Slot	Module	Order number	I Address	Q address	Diagnostic Address	Comment
0	WDGA	WDGA58XXXXXXXXPNAB0XX			4089*	
X1	2 Port PN-IRT-Switch				4088*	
X1 P1 R	Port 1				4087*	
X1 P2 R	Port 2				4086*	
1						

Figure 6.40: Slot 1, highlighted green

← → (1) WDGA

Slot	Module	Order number	I Address	Q address	Diagnostic Address	Comment
0	WDGA	WDGA58XXXXXXXXPNAB0XX			4089*	
X1	2 Port PN-IRT-Switch				4088*	
X1 P1 R	Port 1				4087*	
X1 P2 R	Port 2				4086*	
1	Multiturn 16 Bit + Sing~				4085*	
1.1	AdAP				4085*	
1.2	Standard Telegram 81		0...11	0...3		

Figure 6.41: Slot 1.2 with inserted telegram 81

You can also set the corresponding I/O addresses. To do so, double-click on the respective field (see Figure 6.42) and change the addresses in the "Addresses" tab (see Figure 6.43).

Slot	Module	Order number	I Address	Q address	Diagnostic Address	Comment
0	WDGA	WDGA58XXXXXXXXPNAB0X			4085*	
X1	2-Port PN/RT-Switch				4086*	
X1 P1 R	Port 1				4087*	
X1 P2 R	Port 2				4088*	
1	Multiturn 16 Bit + Sing~				4085*	
1.1	ModP				4085*	
1.2	Standard Telegram 81		0...11	0...3		

Figure 6.42: Change the I/O addresses

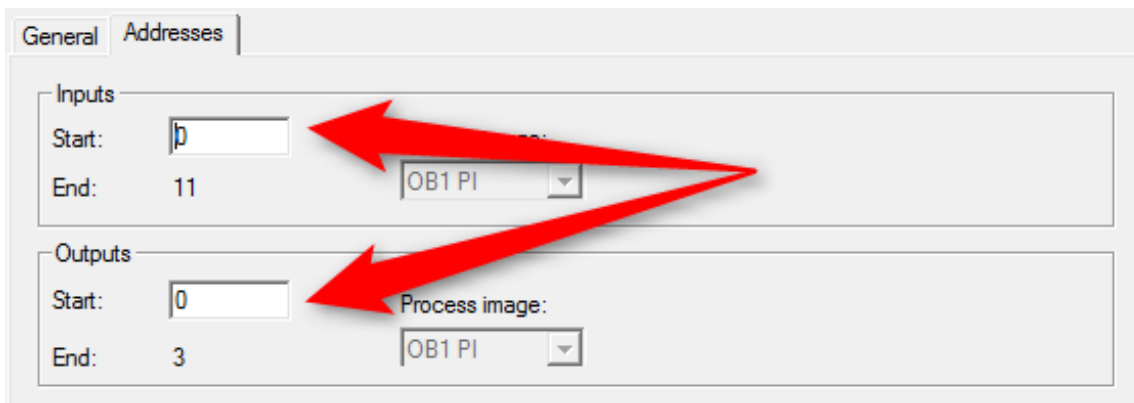

Figure 6.43: "Addresses" tab

Save the configuration by clicking the "Save and transmit" button and load it into your PLC ("Download to module").

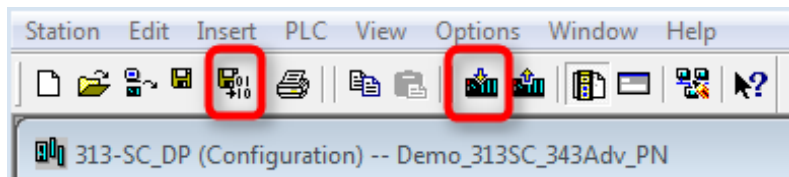

Figure 6.44: Save and transmit — Download to module

You can use a variable table to display the encoder's I/O data for test purposes (see Figure 6.45 and Figure 6.46).

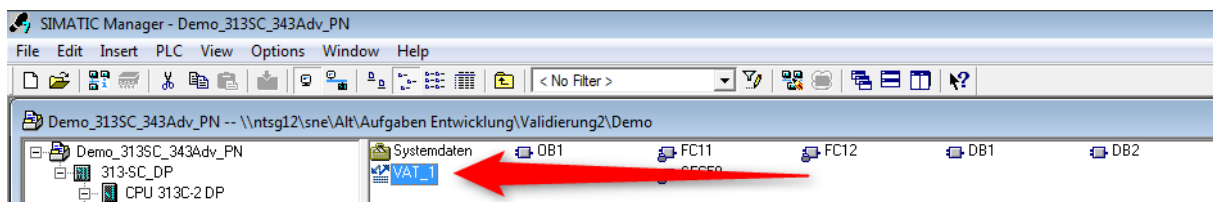
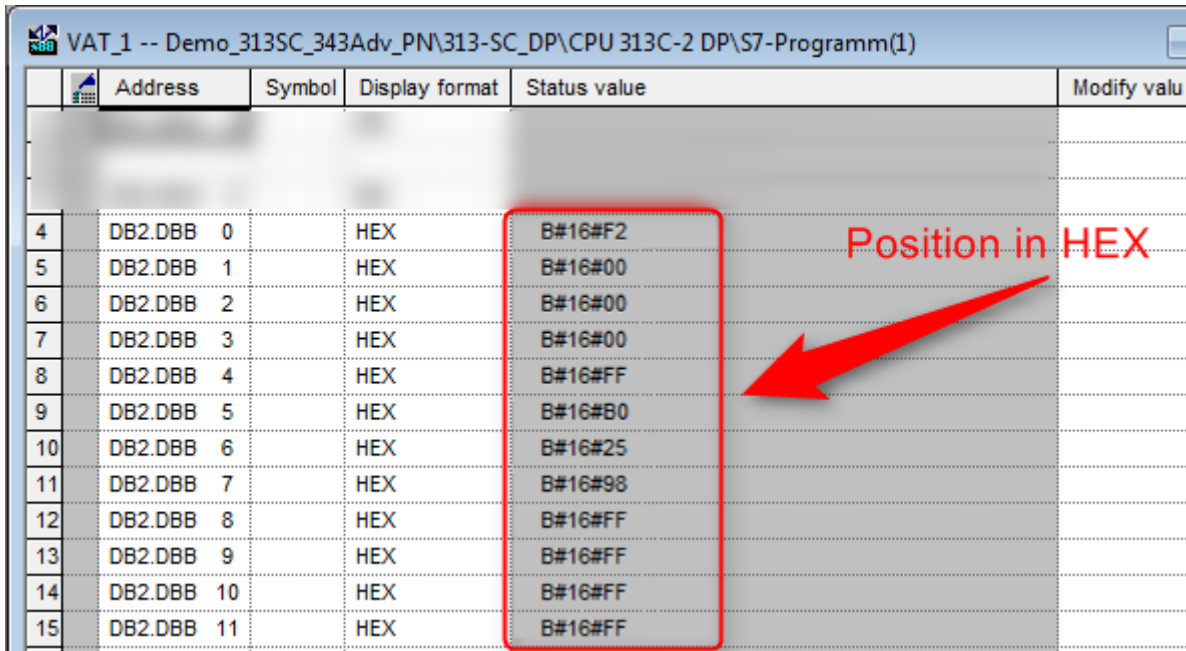

Figure 6.45: Variable table



	Address	Symbol	Display format	Status value	Modify valu
4	DB2.DBB 0		HEX	B#16#F2	
5	DB2.DBB 1		HEX	B#16#00	
6	DB2.DBB 2		HEX	B#16#00	
7	DB2.DBB 3		HEX	B#16#00	
8	DB2.DBB 4		HEX	B#16#FF	
9	DB2.DBB 5		HEX	B#16#B0	
10	DB2.DBB 6		HEX	B#16#25	
11	DB2.DBB 7		HEX	B#16#98	
12	DB2.DBB 8		HEX	B#16#FF	
13	DB2.DBB 9		HEX	B#16#FF	
14	DB2.DBB 10		HEX	B#16#FF	
15	DB2.DBB 11		HEX	B#16#FF	

Figure 6.46: HEX position value

## 7 Technical data

### 7.1 Properties

<b>Interfaces</b>	2x M12 ports 4-pole D-coded	
	1x M12 connector 4-pole A-coded	
<b>Profinet data rate</b>	Max. 100 Base-TX	
<b>Diagnostic LEDs</b>	Data traffic and connection monitoring:	L/A1: Port 1, L/A2: Port 2
<b>Status LEDs</b>	Status display for encoder and bus	STAT, MOD
<b>Operating temperature</b>	-40°C to +85°C	
<b>Storage temperature</b>	-40°C to +125 °C	
<b>Operating voltage</b>	10 VDC to 32 VDC	
<b>Current consumption</b>	typ. 125 mA	
<b>Power consumption</b>	typ. 3 W	
<b>Weight</b>	WDGA 58B, 58F:	approx. 700 g
	WDGA 58E:	approx. 410 g
<b>Housing</b>	Flange material:	Aluminium
	Flange material (rear):	Steel housing, chromium-plated, magnetically shielded
	Connection hood:	Die-cast aluminium, powder-coated

### 7.2 Dimensions

#### 7.2.1 WDGA 58B

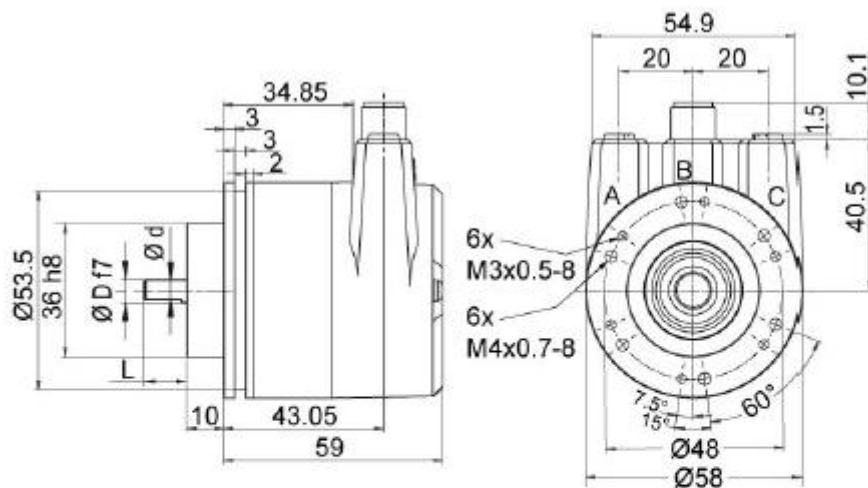

D = 6,      L = 12, d = 5.3 shaft with flat  
 D = 8,      L = 20, d = 7.5 shaft with flat  
 D = 10,     L = 20, d = 10 shaft without flat  
 D = 3/8", L = 20, d = 8.3 shaft with flat

\*option full IP67 version: D = 10 mm  
 D = 10. L = 20. d = 9 shaft with flat

Figure 7.1: Dimensions WDGA 58B



### 7.2.2 WDGA 58F

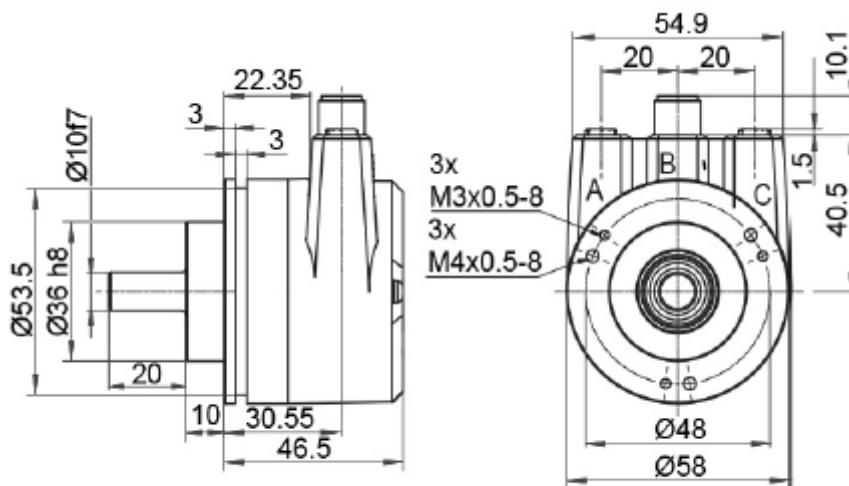

Figure 7.2: Dimensions WDGA 58F

### 7.2.3 WDGA 58E

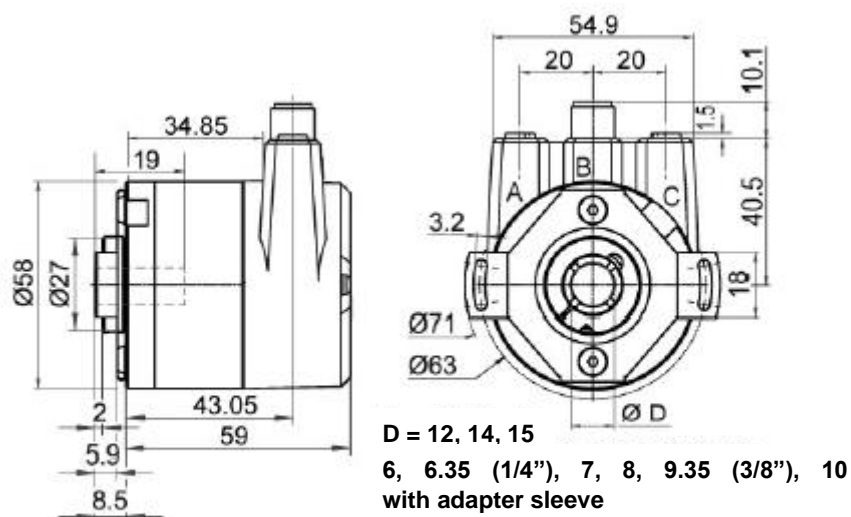

Figure 7.3: Dimensions WDGA 58E

## 8 Technical support

### Technical application advisor

Do you have any questions about this product?

Our technical application advisor will be pleased to help you.

Tel.: +49 (0) 67 22 / 99 65 414  
E-Mail: [support-wa@wachendorff.de](mailto:support-wa@wachendorff.de)

Notes: